

# PREFAB BETON IN UTILITEITSBOUW

Detail	Pagina	Detail	Pagina
P 00	52/53	D 31	81
P 01		D 32	82
P 02	54/55	D 33	
P 03		D 34	83
P 04	56/57	D 35	84
P 05		D 36	85
P 06	58/59	D 37	
D 01	60	D 38	86
D 02		D 39	
D 03	61	D 40	87
D 04	62	D 41	
D 05	63	D 42	88
D 06	64	D 43	
D 07		D 44	89
D 08	65	D 45	
D 09	66	D 46	90
D 10	67	D 47	
D 11	68	D 48	91
D 12	69	D 49	
D 13		D 50	92
D 14	70	D 51	
D 15		D 52	93
D 16	71	D 53	
D 17		D 54	94
D 18	72	D 55	
D 19		D 56	95
D 20	73	D 57	
D 21		D 58	96
D 22	74	D 59	
D 23		D 60	97
D 24	75	D 61	98
D 25	76	D 62	99
D 26		D 63	100
D 27	77	D 64	101
D 28	78	D 65	102
D 29	79	D 66	103
D 30	80		

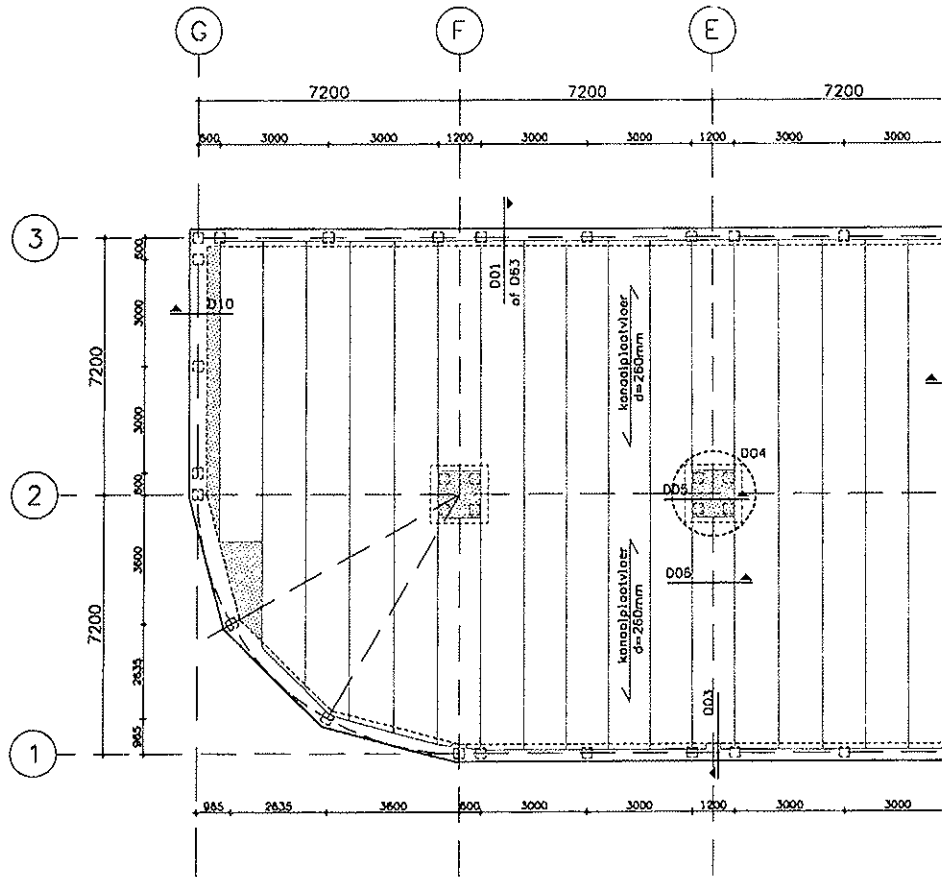

Funderingsoverzicht

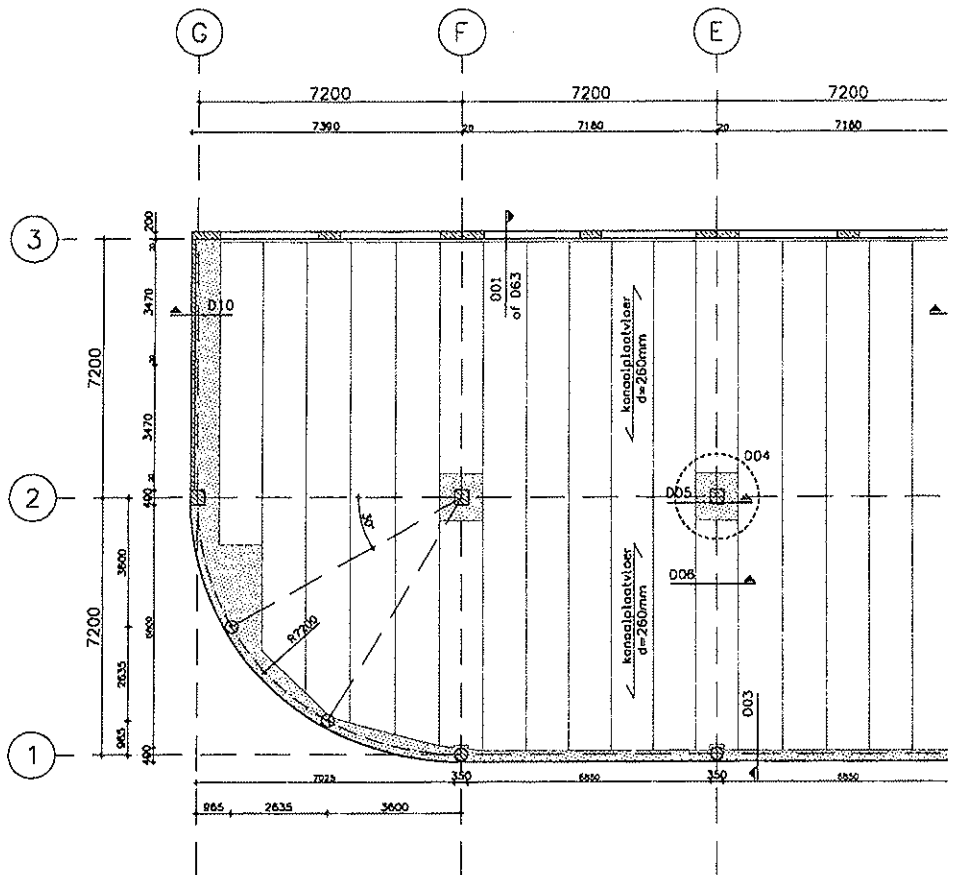

Begane grond

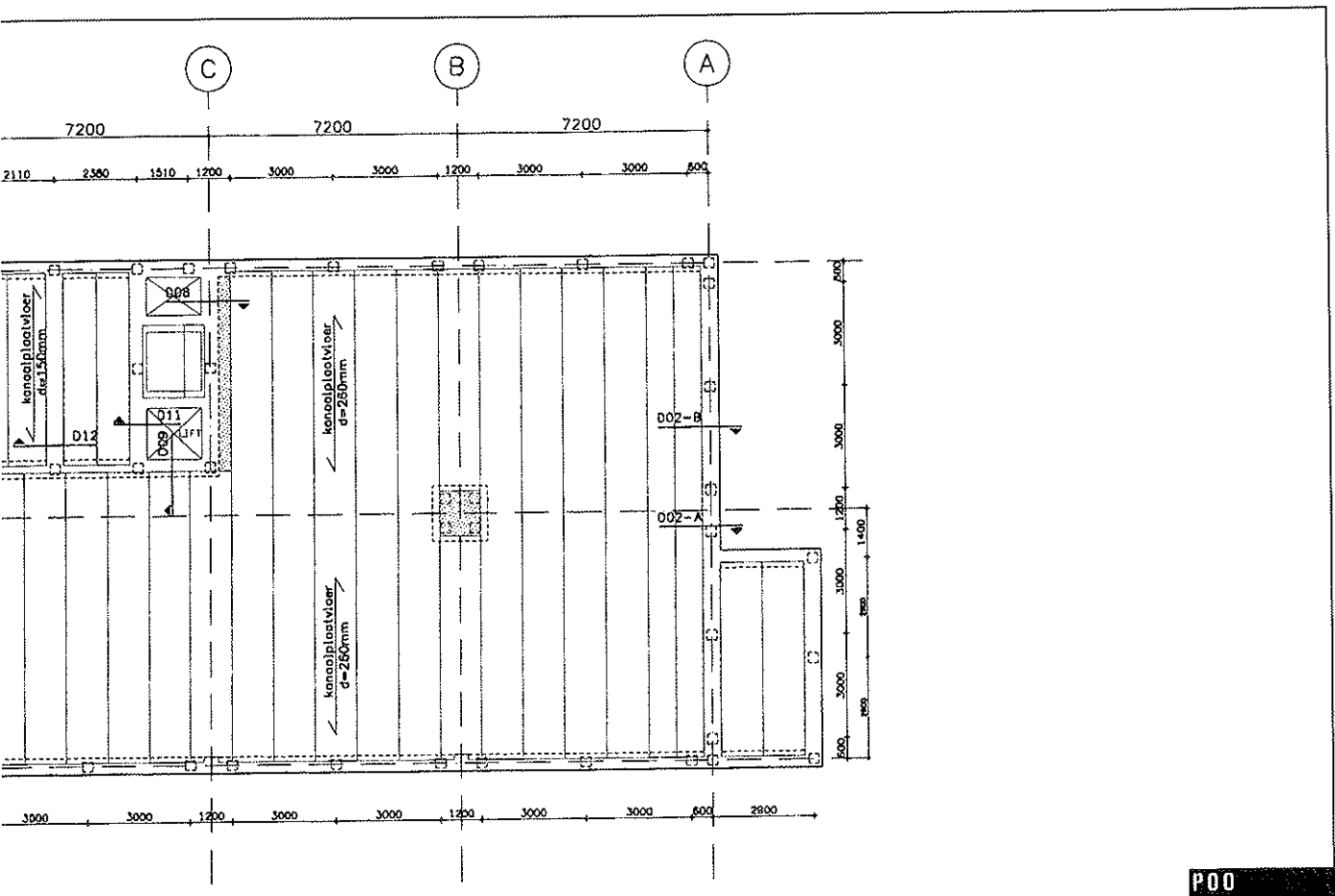

P00

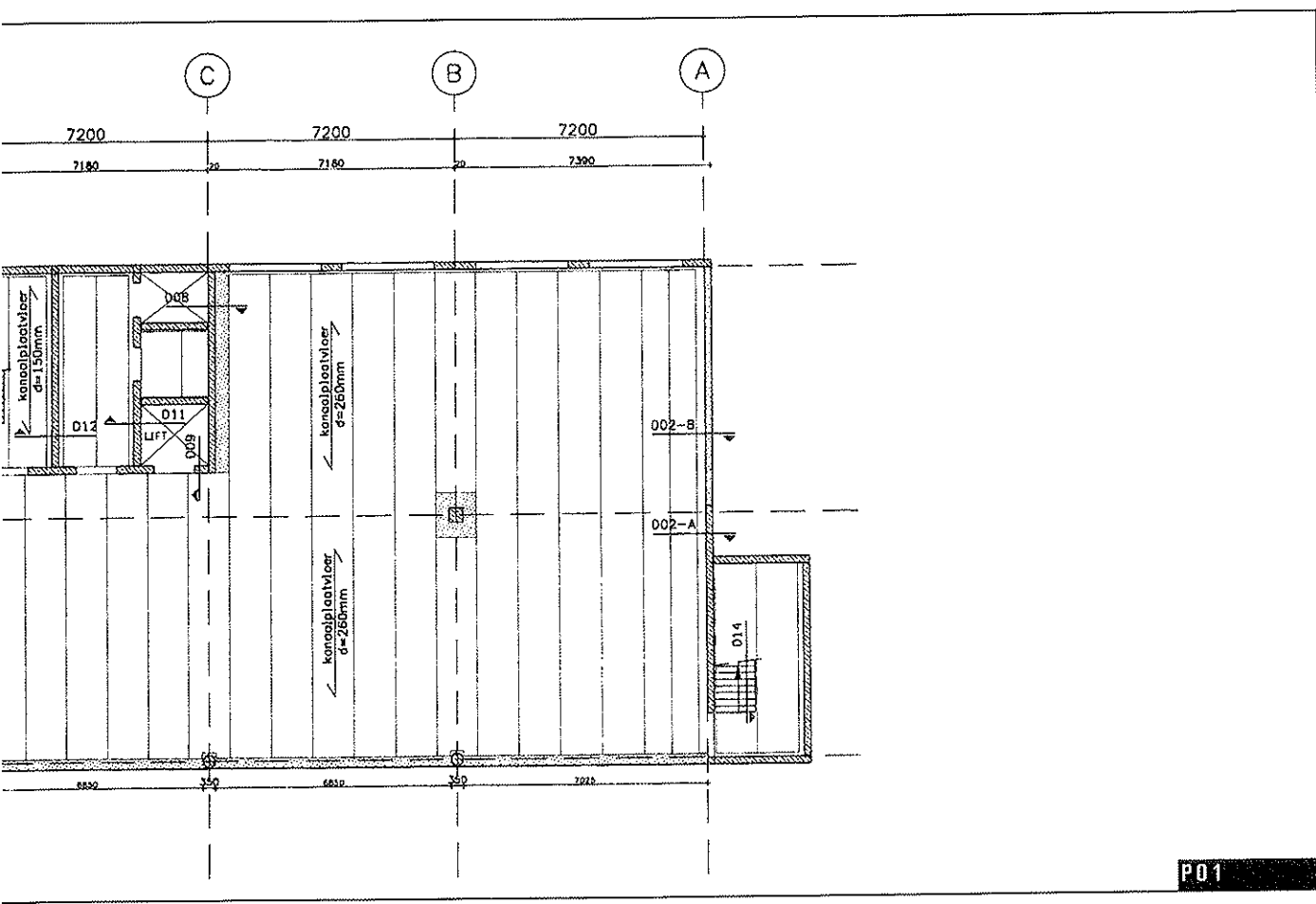

P01





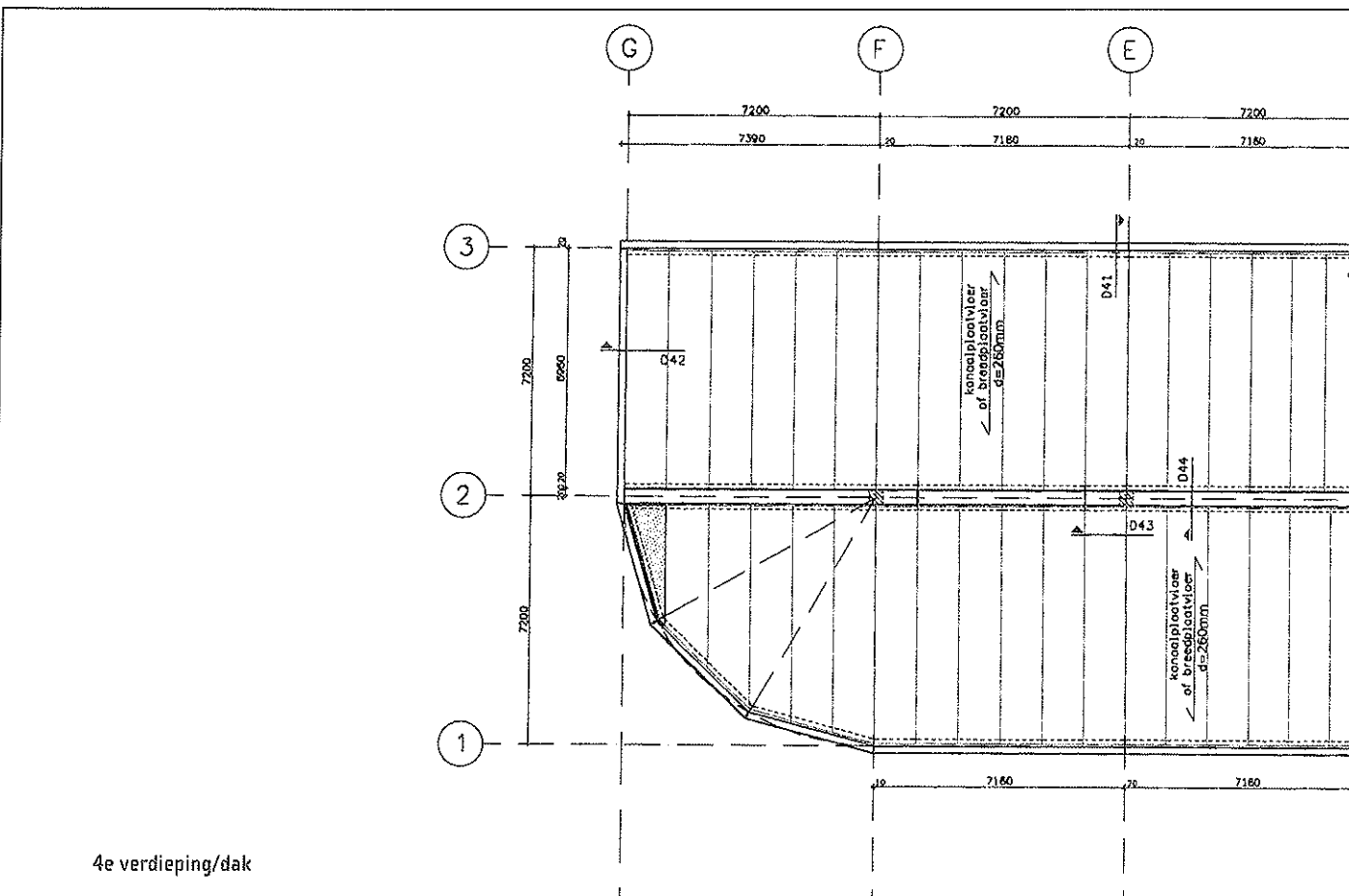
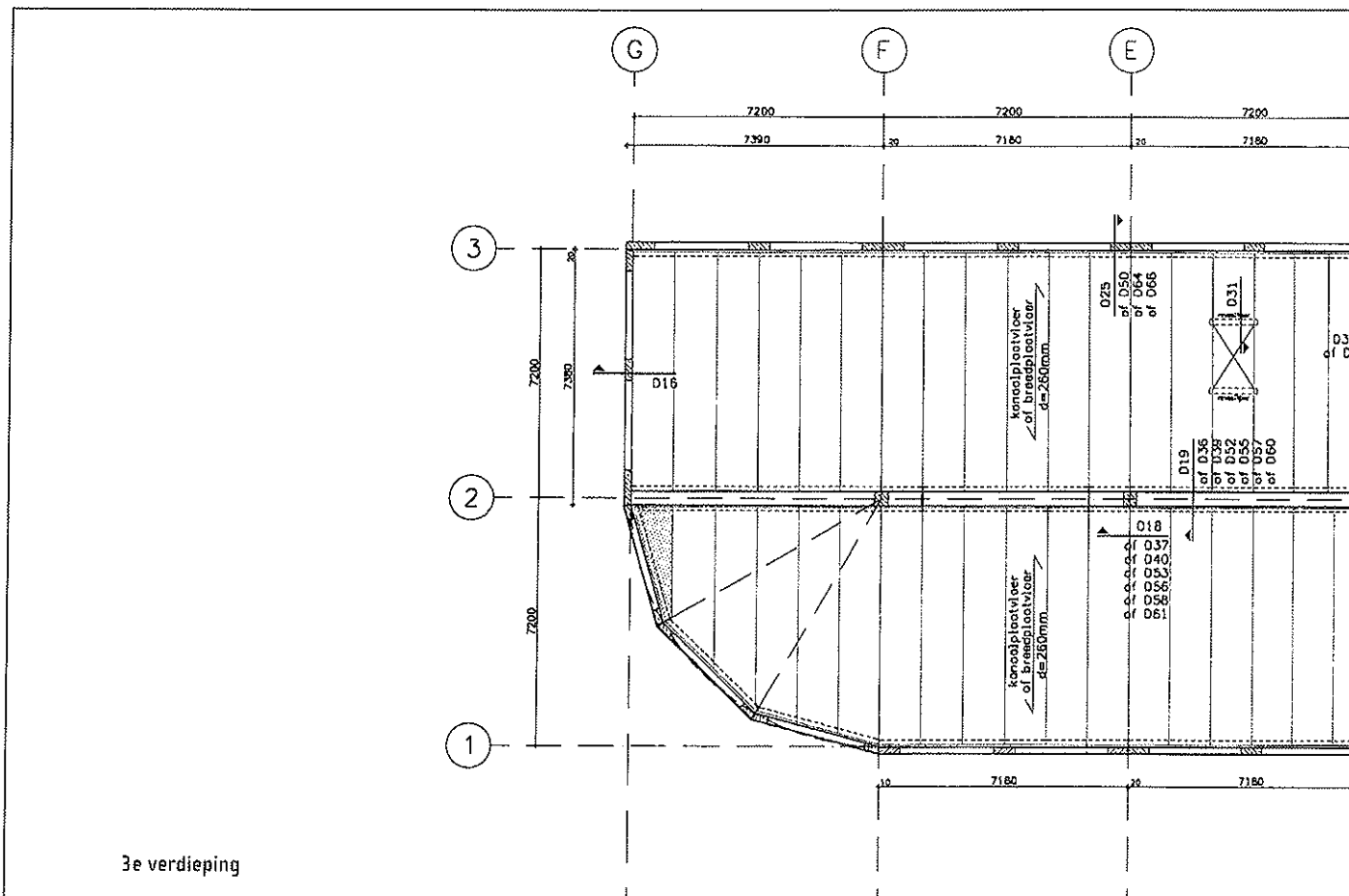

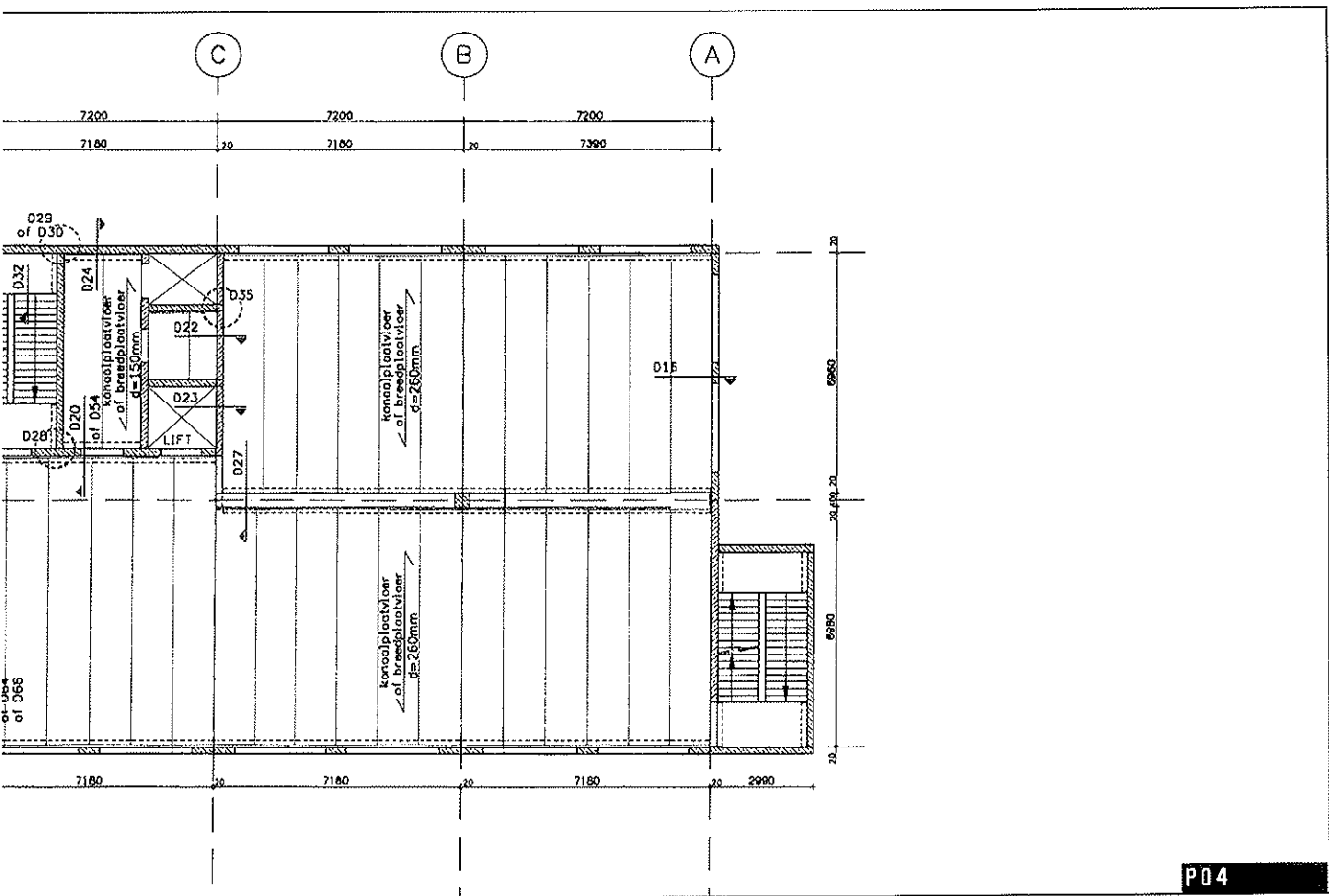

P04

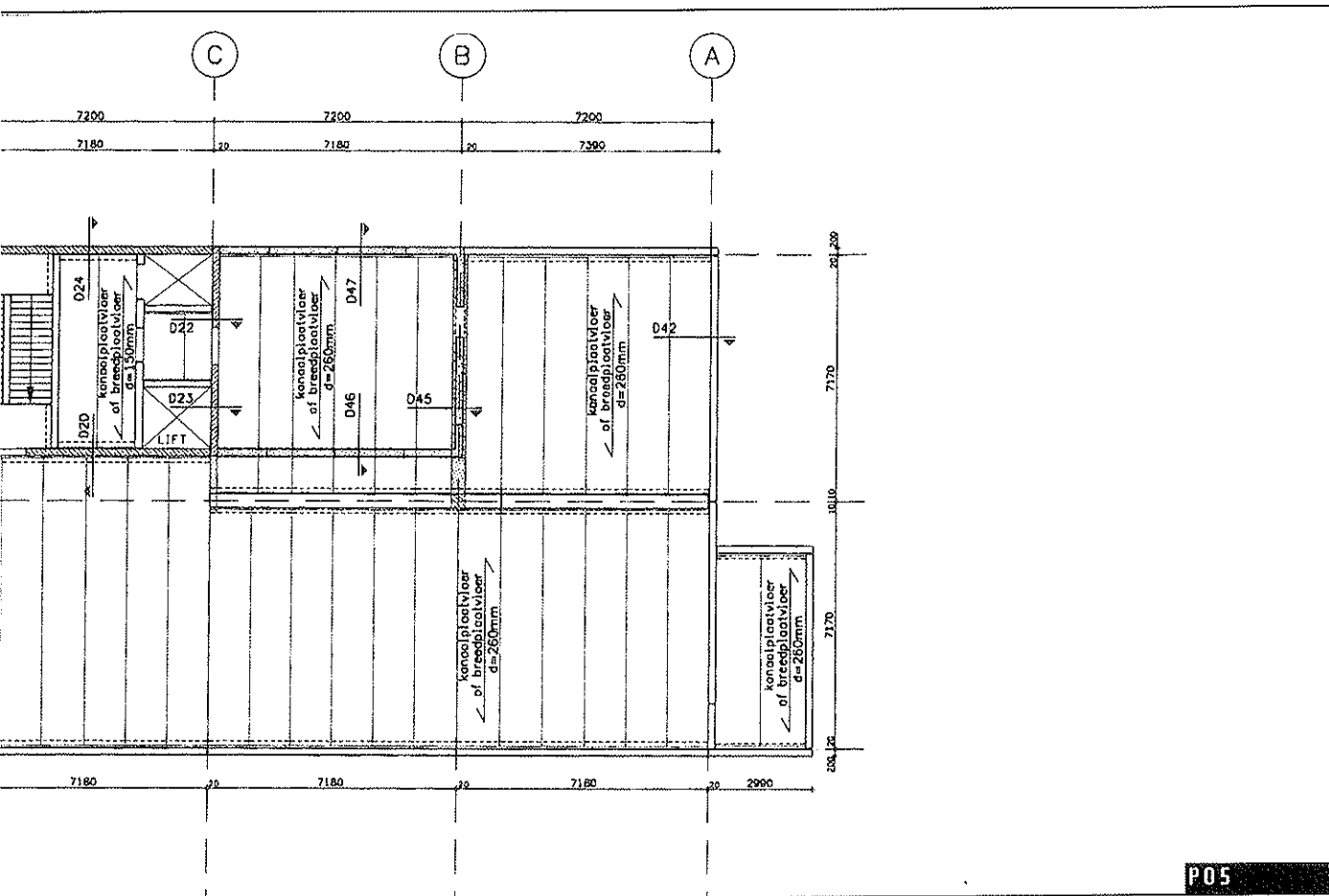

P05

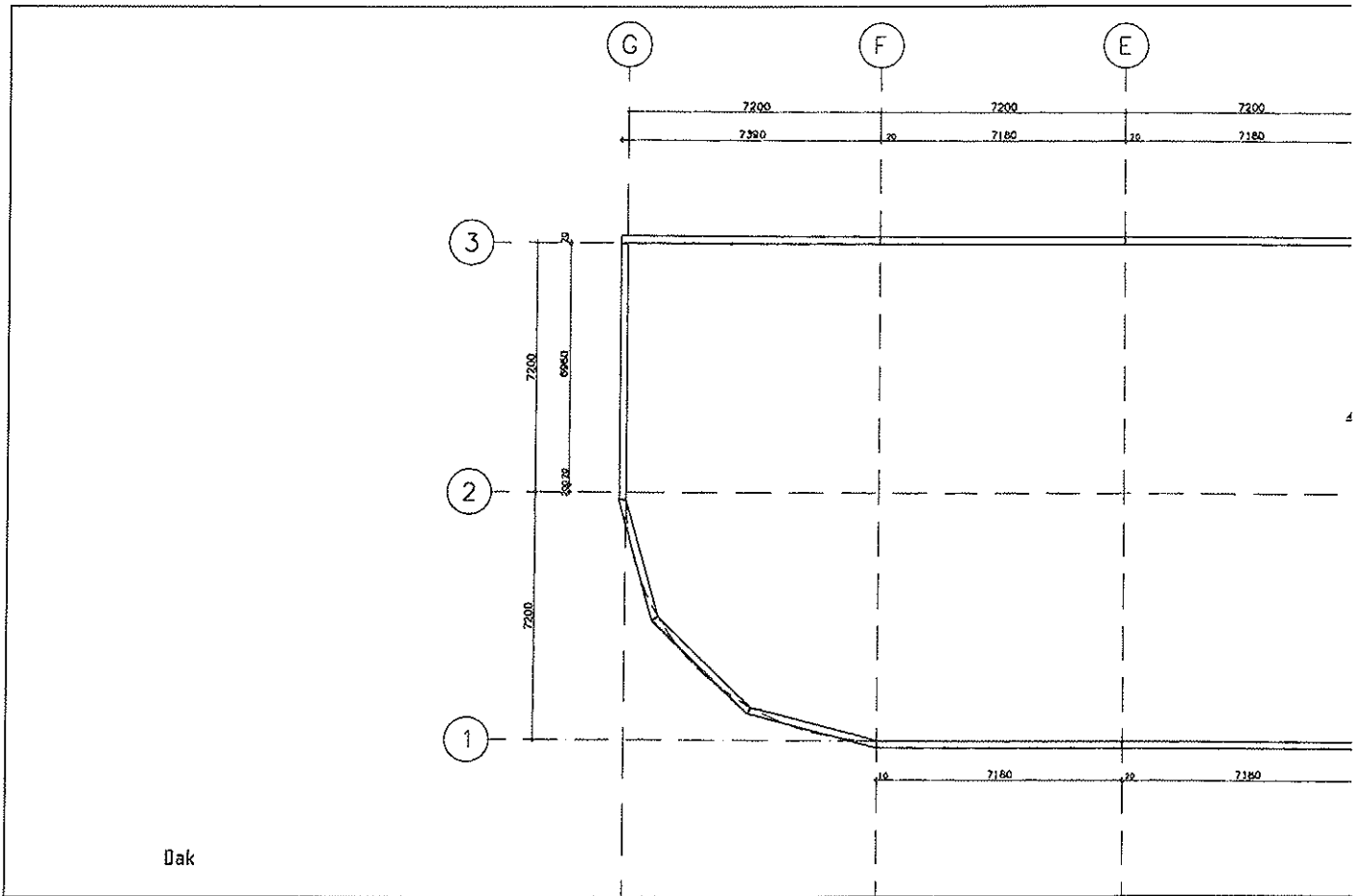



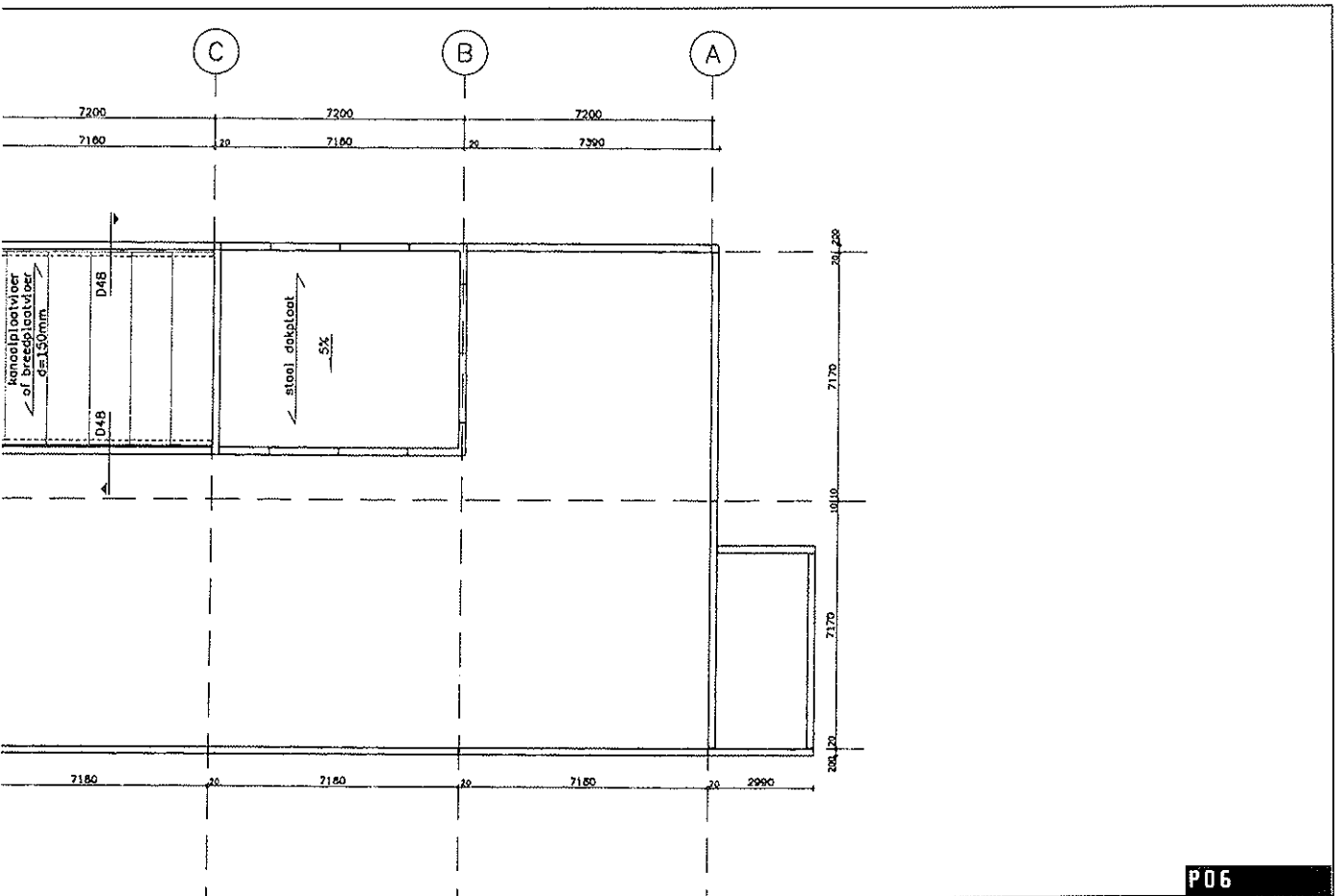

D1  
D2

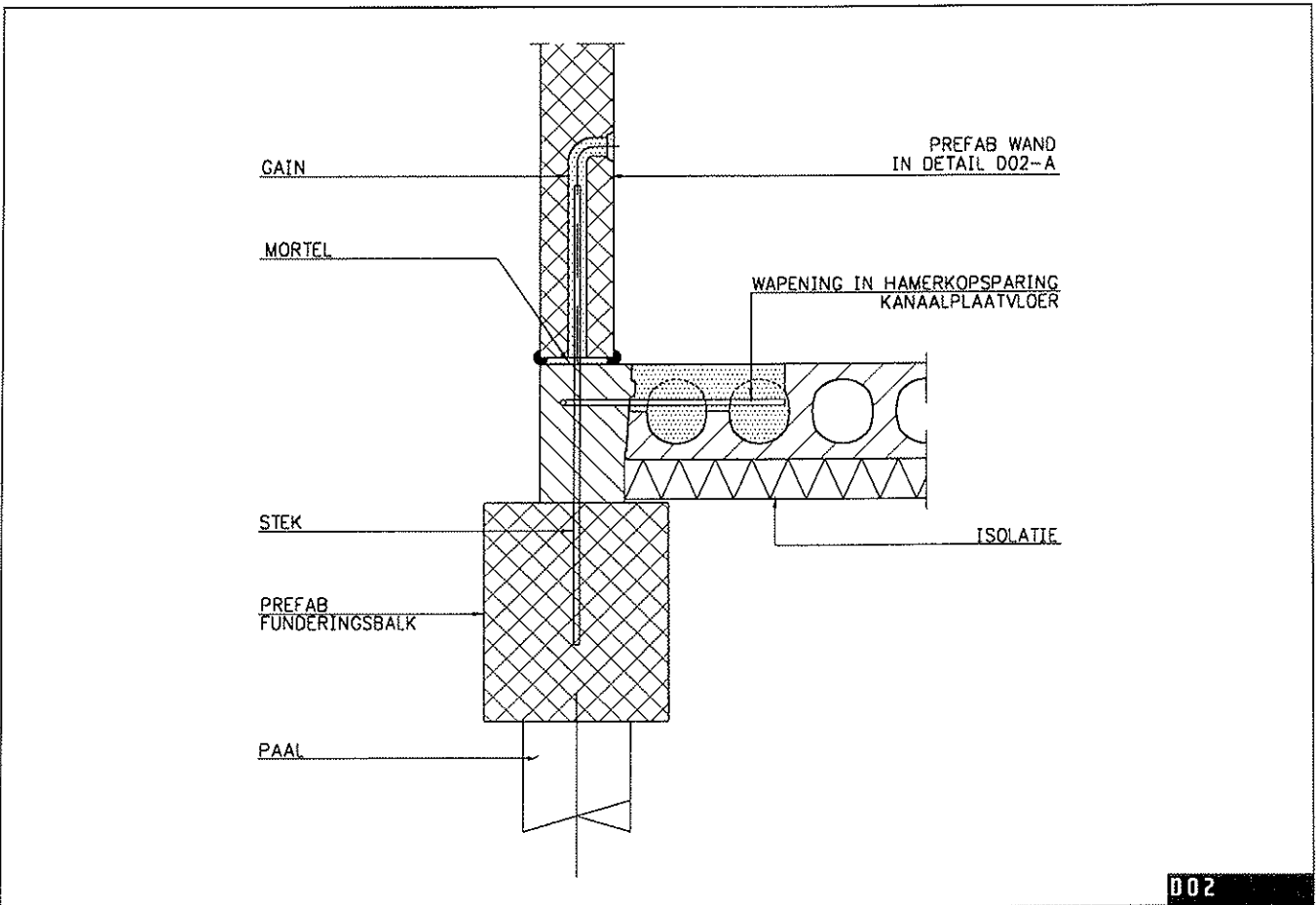
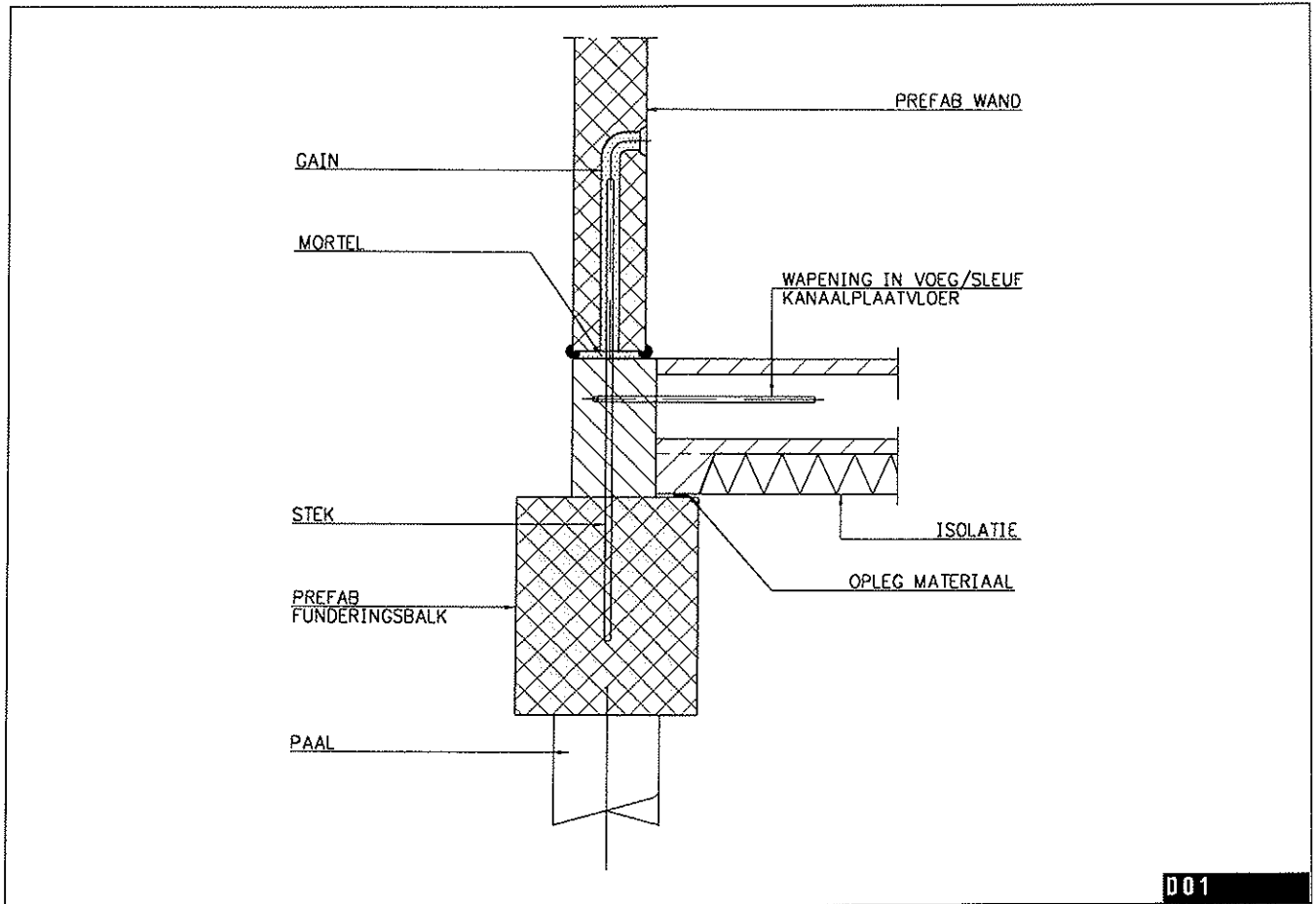

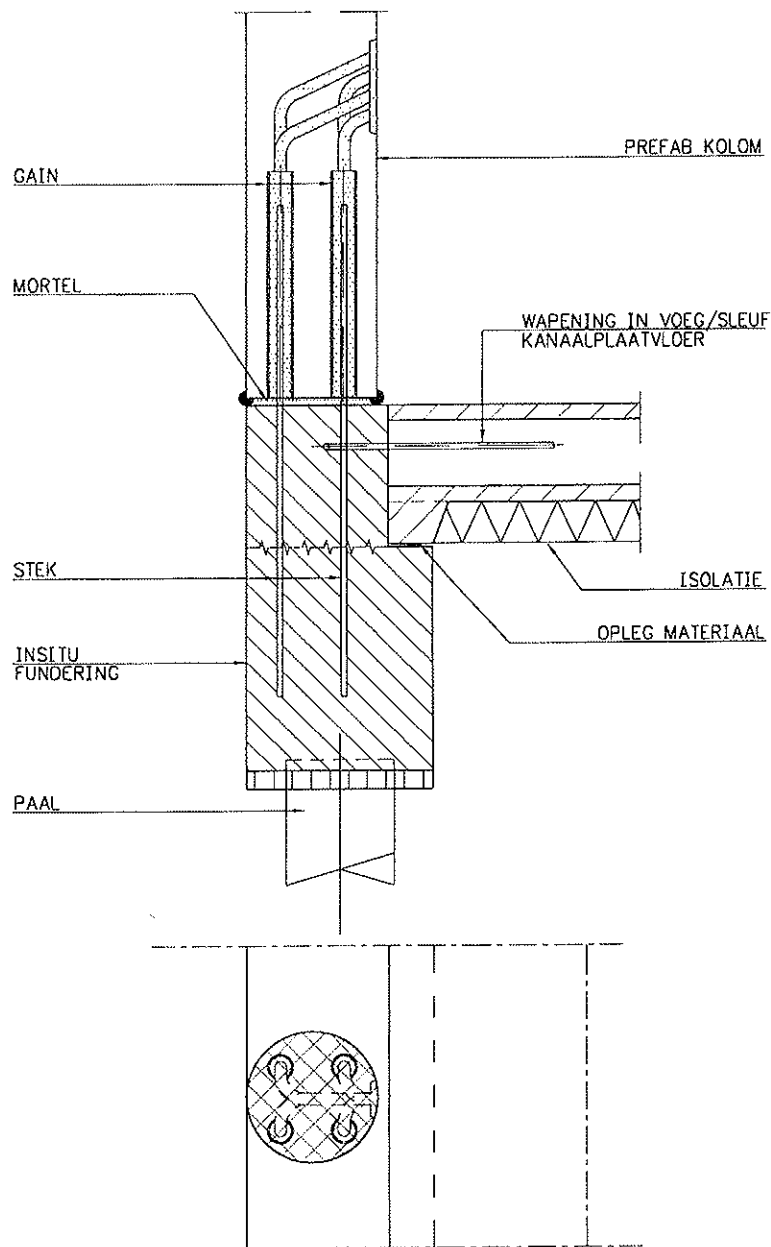

04

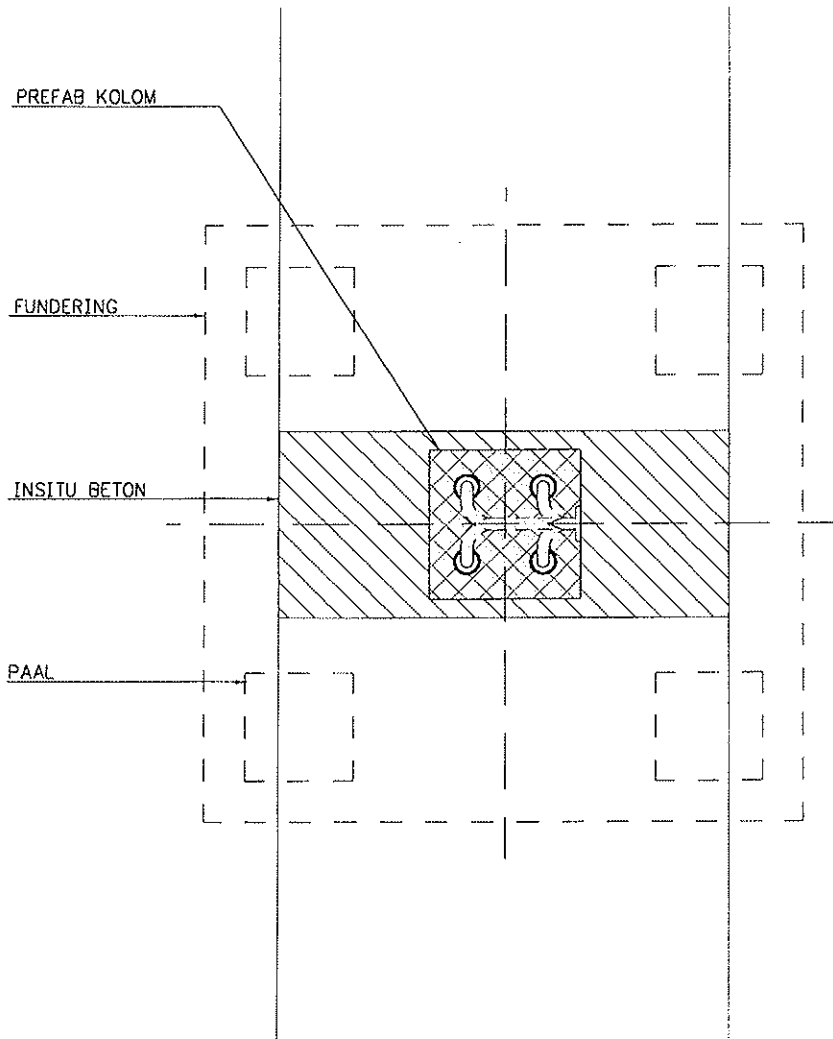

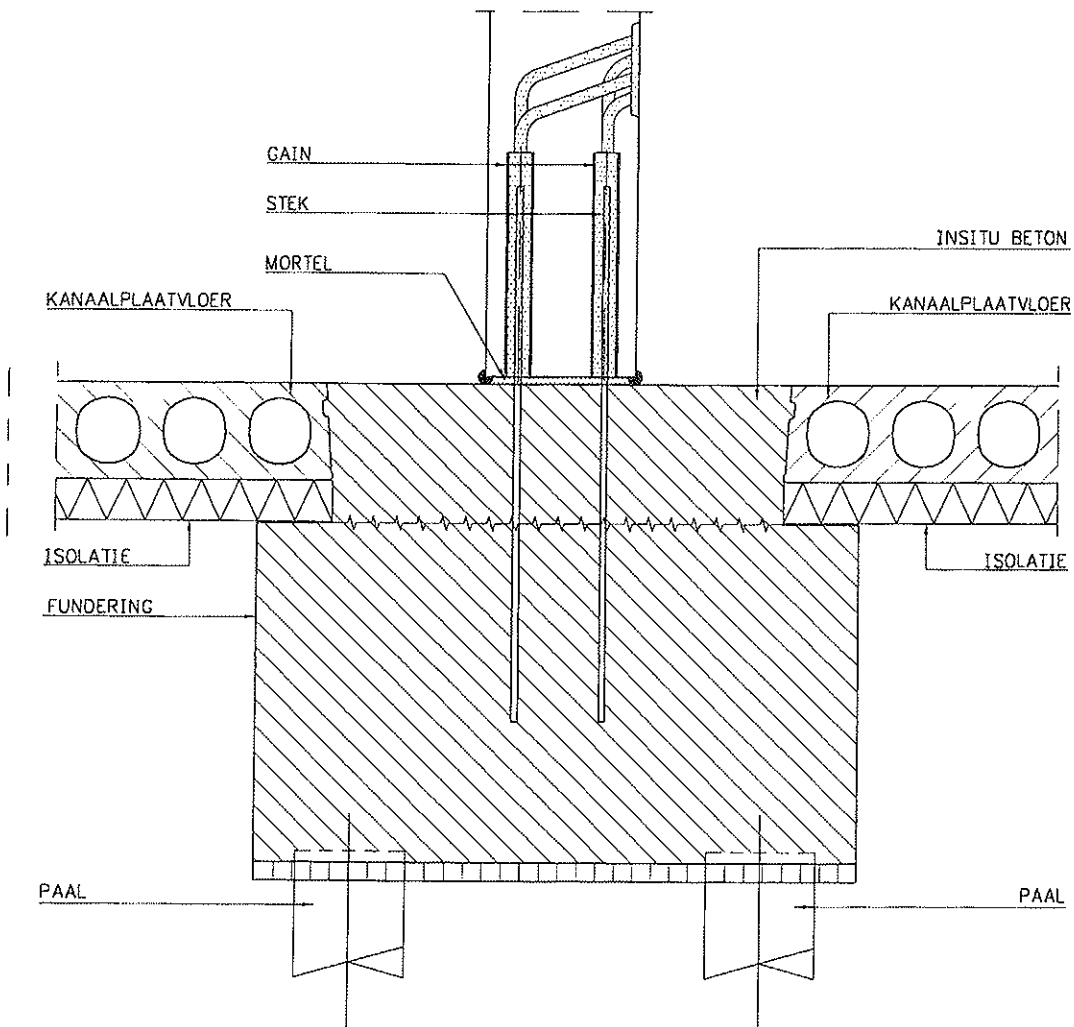

D6  
D7

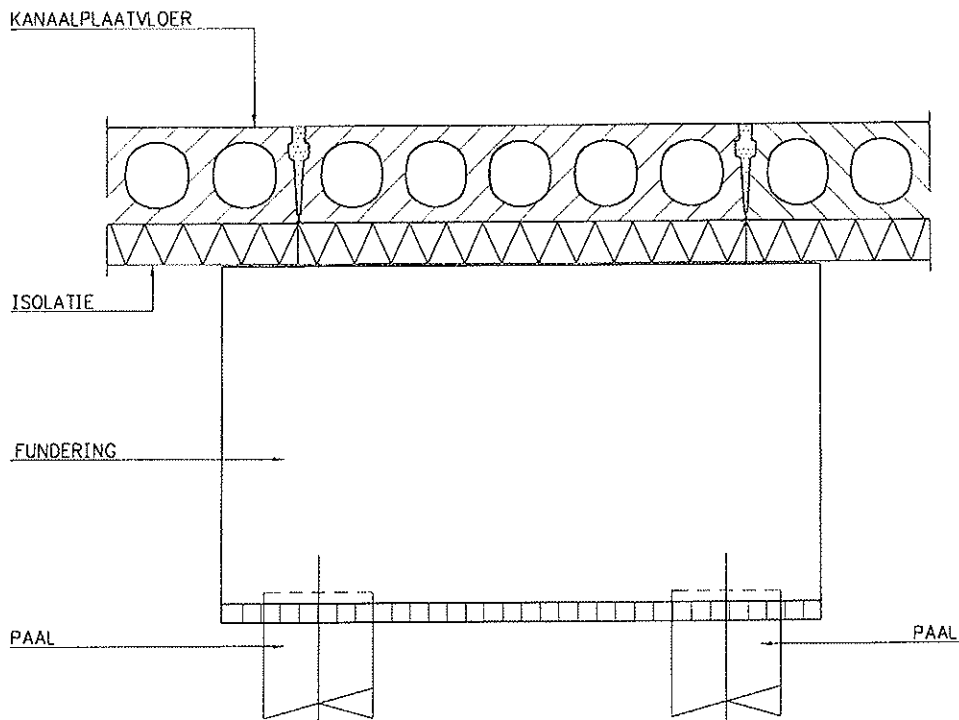

D06

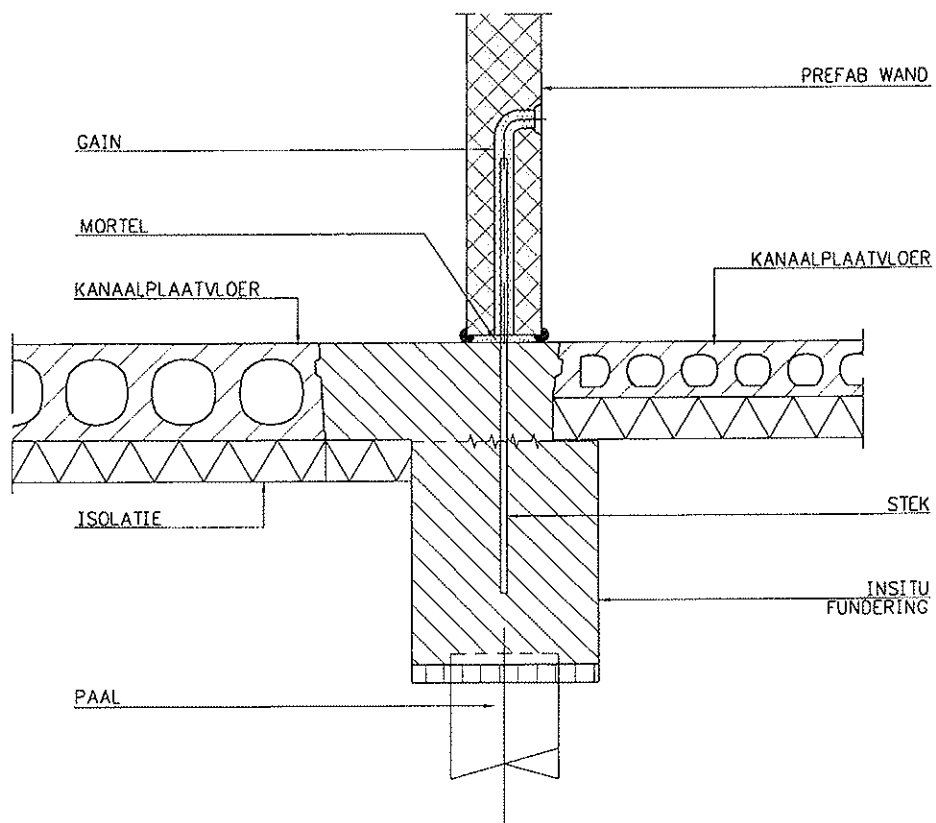

D07

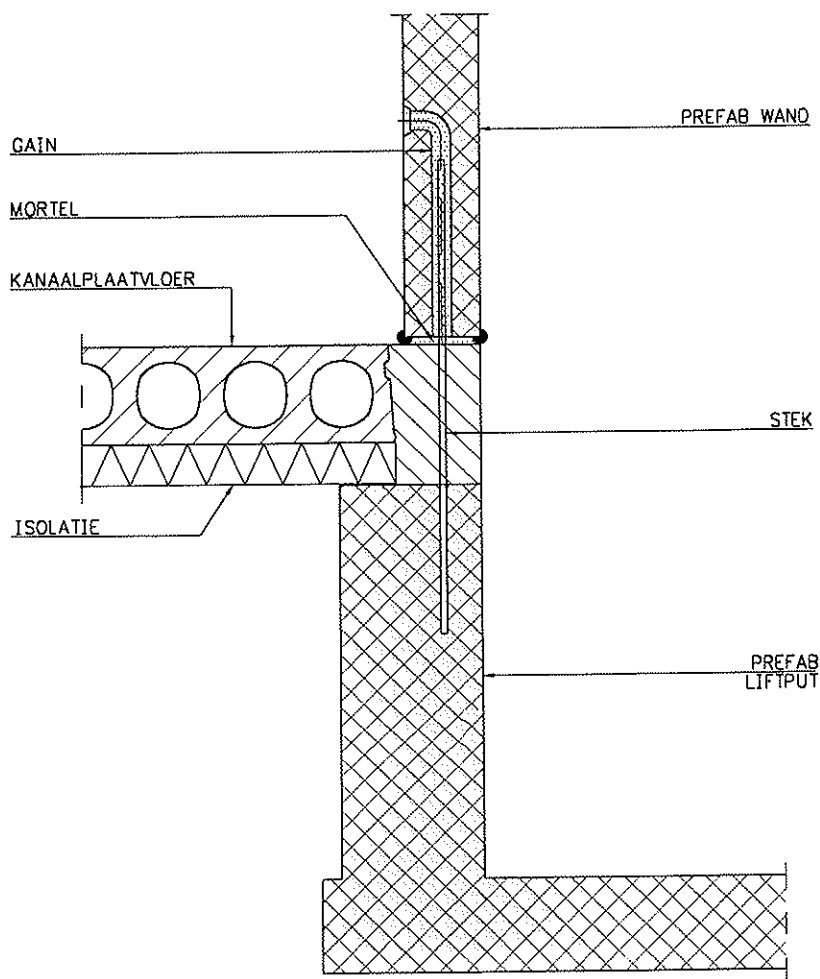

D9

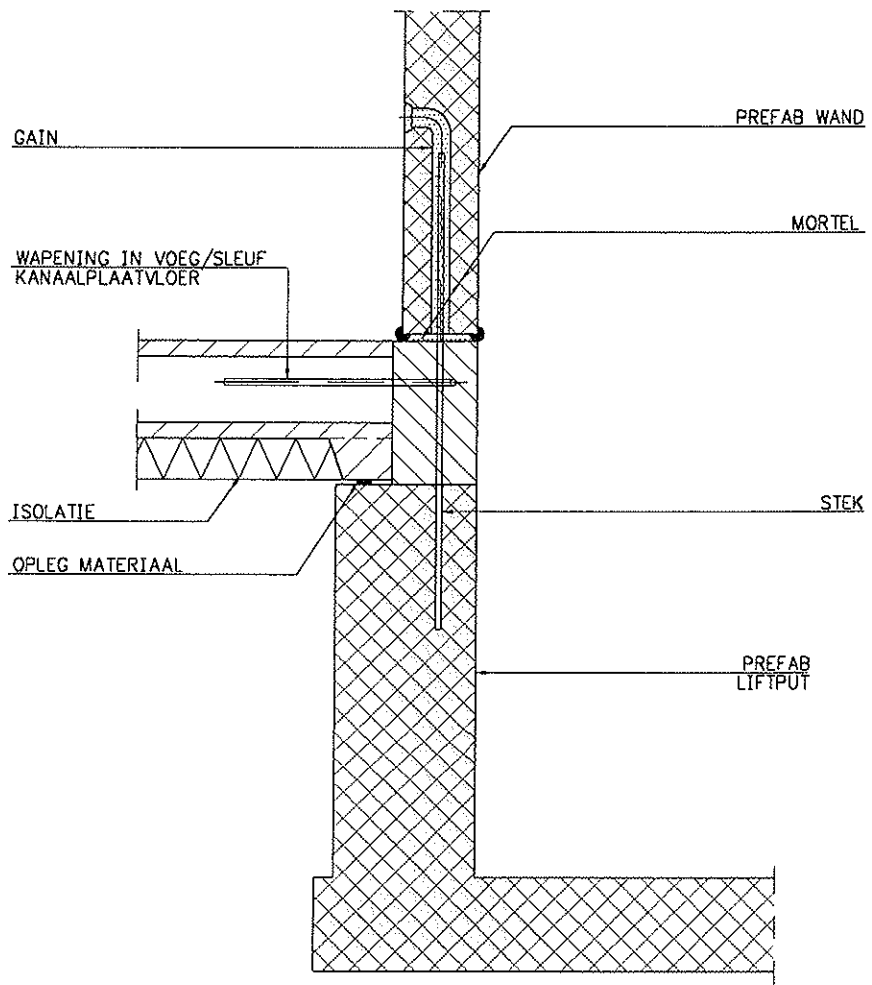

D09



D10

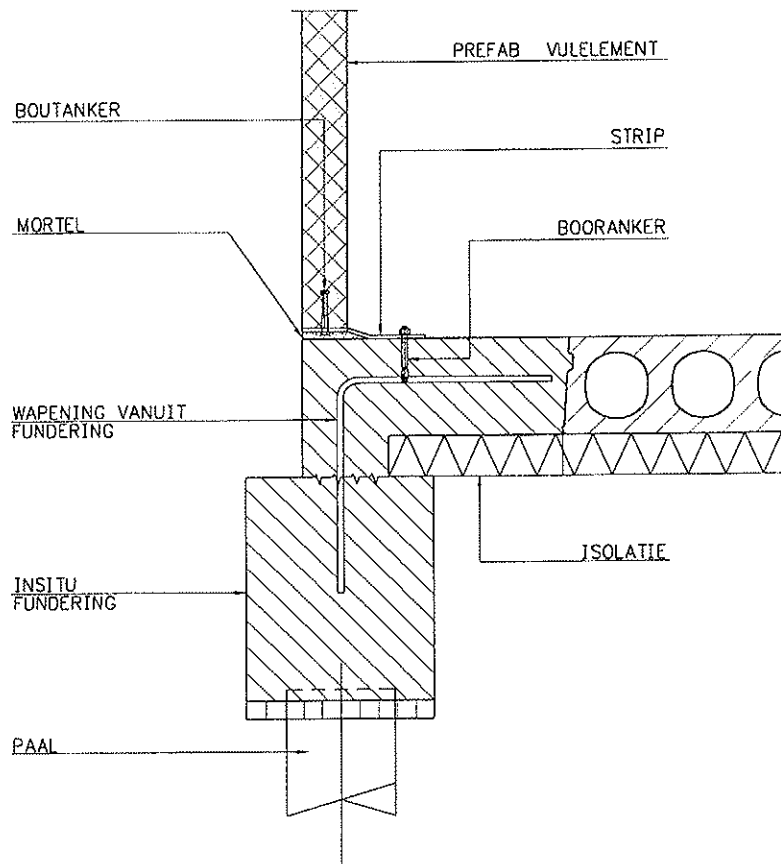

D10

D 11

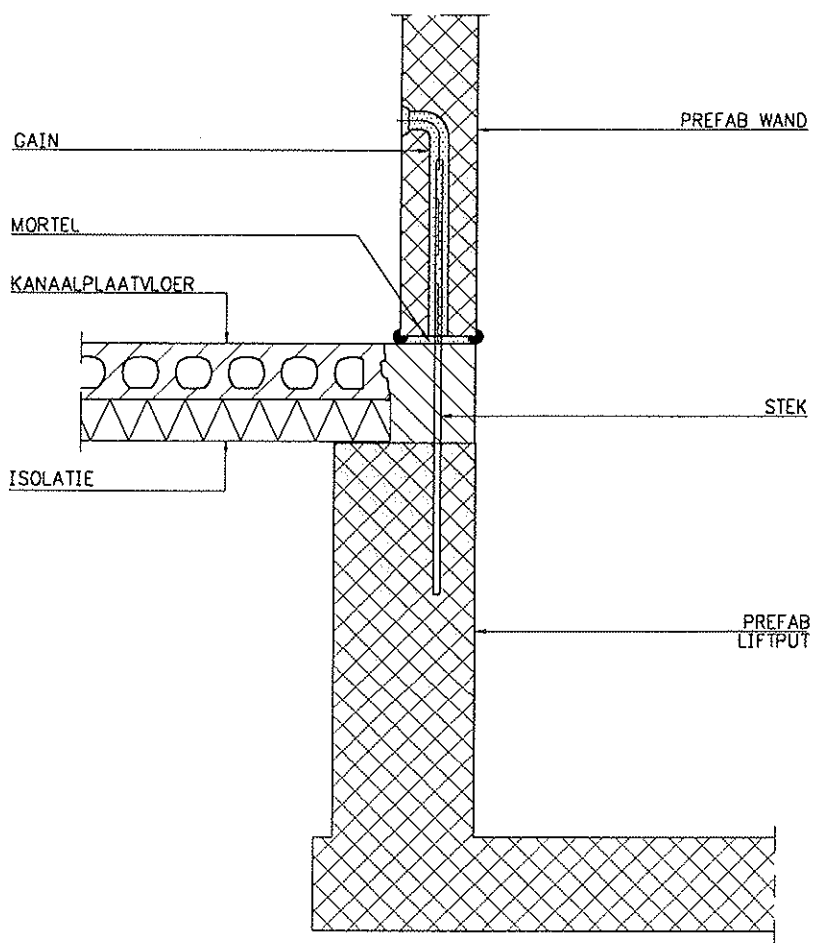

D 11

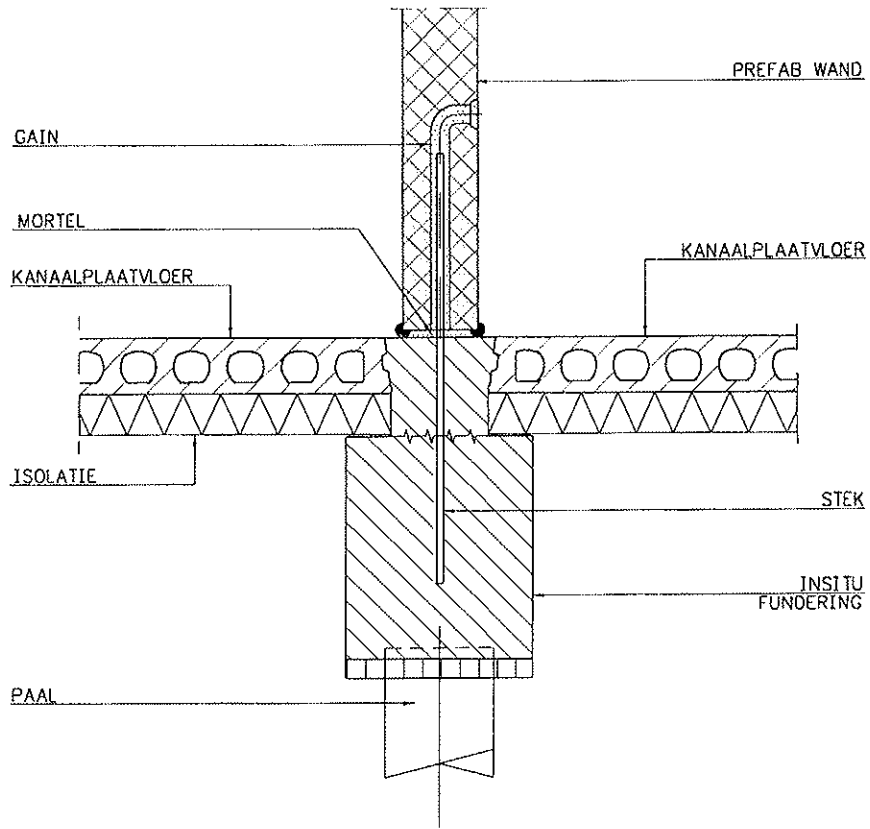

012  
013

012

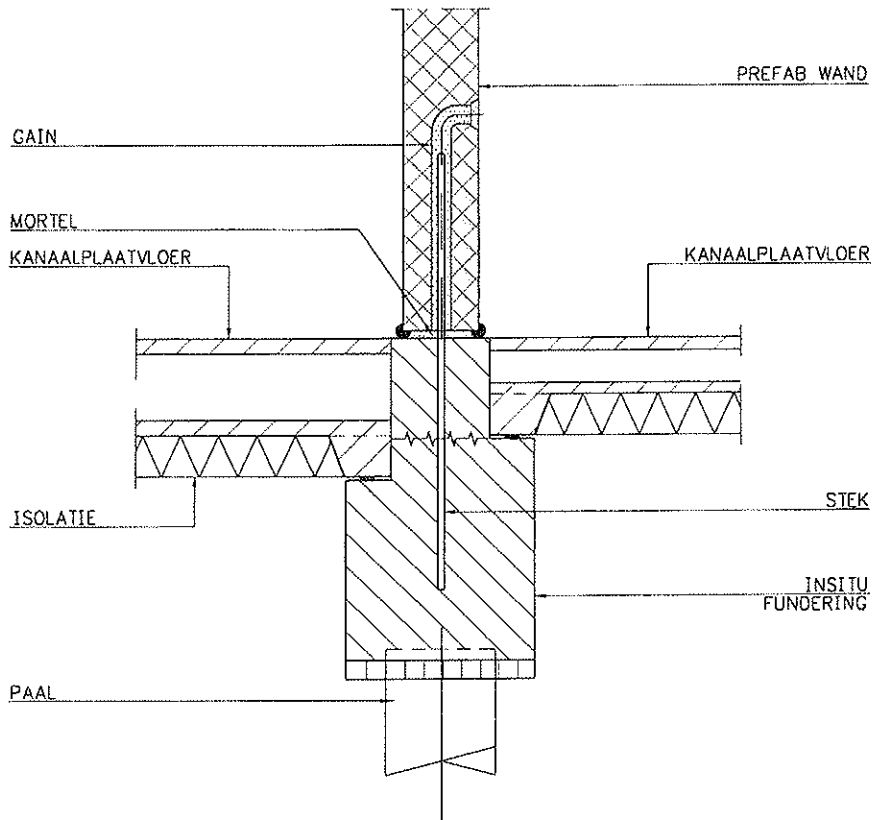

013

D 14  
D 15

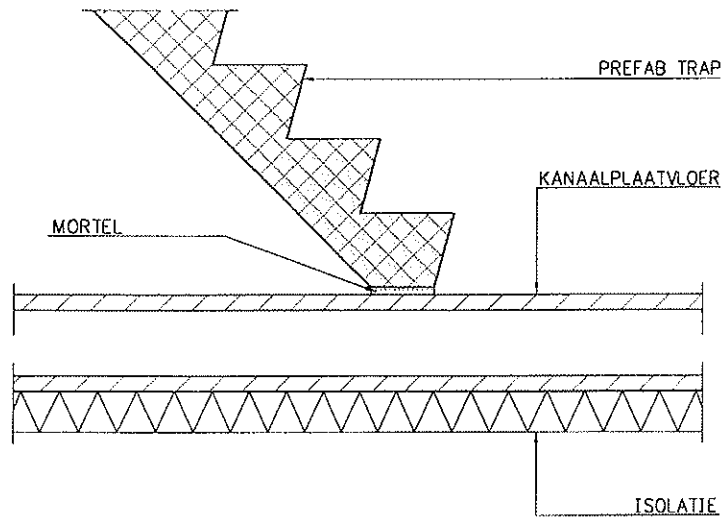

D 14

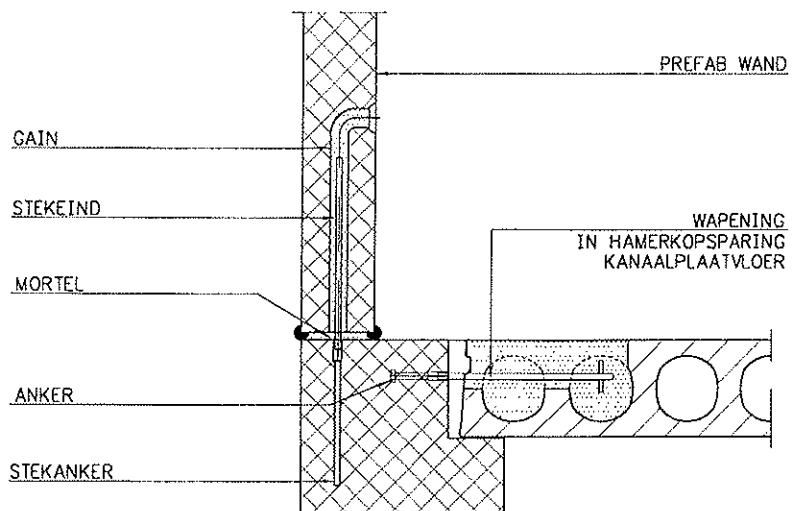

D 15



D 18  
D 19

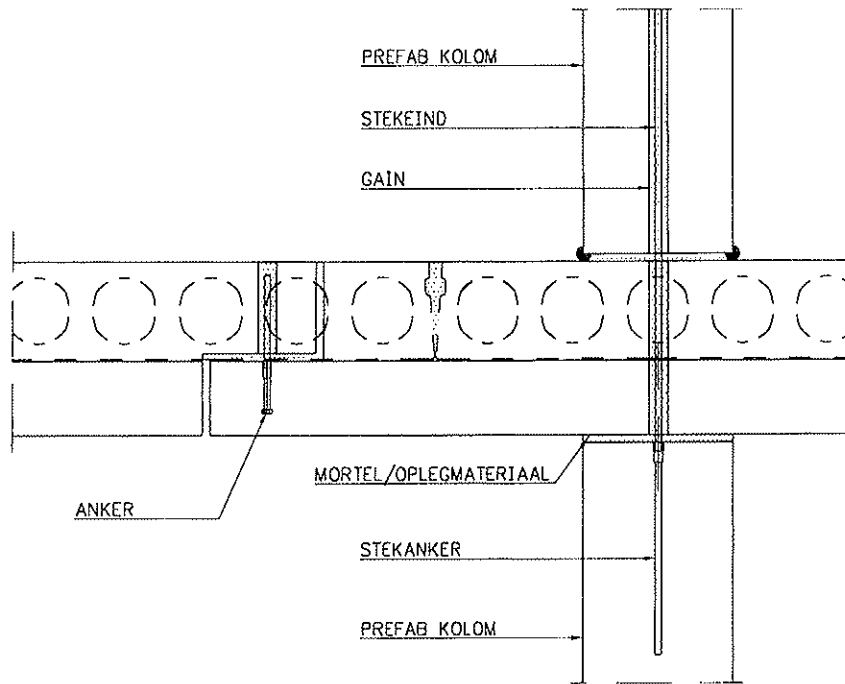

D 18

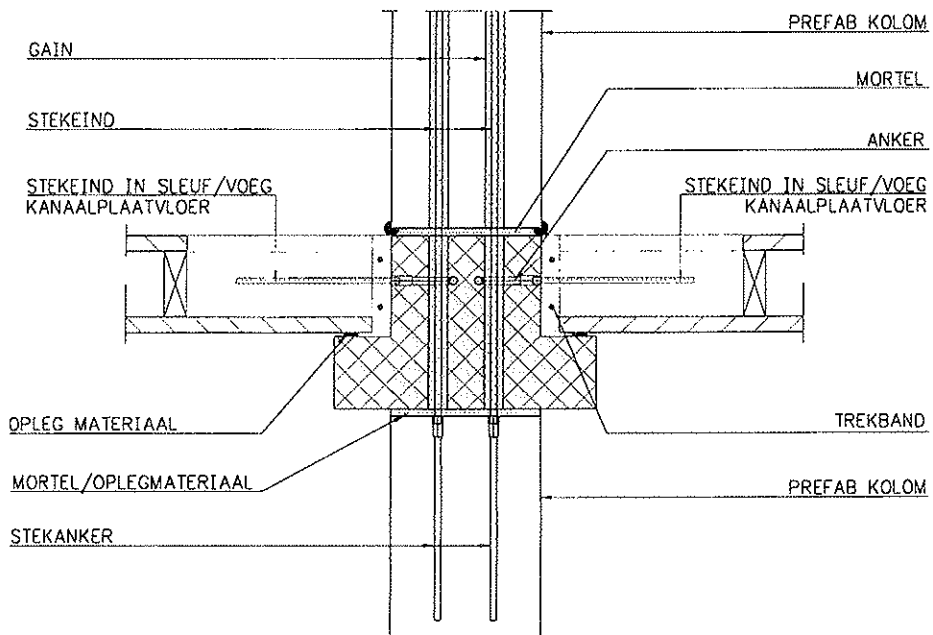

D 19

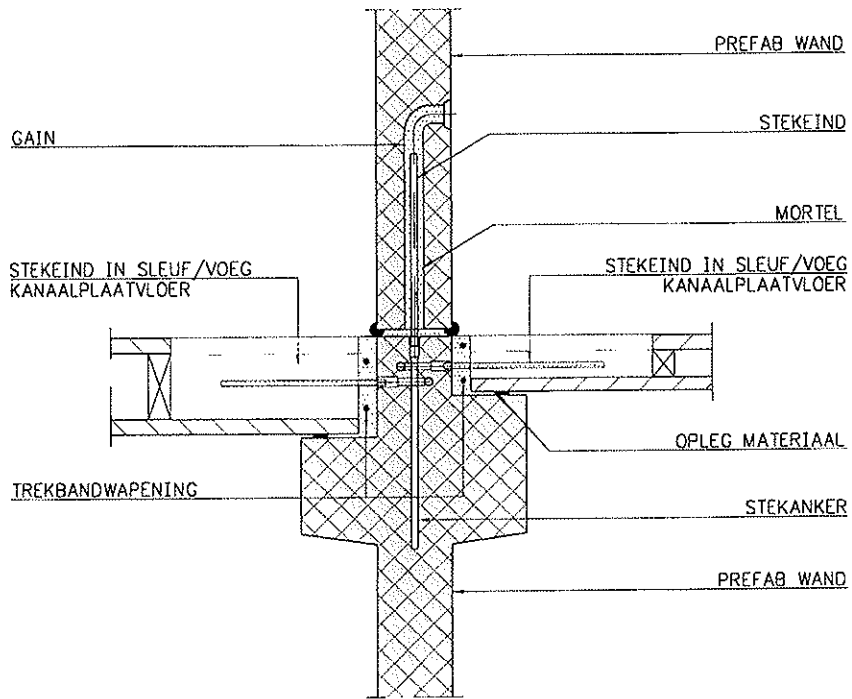

D 20  
D 21

D 20

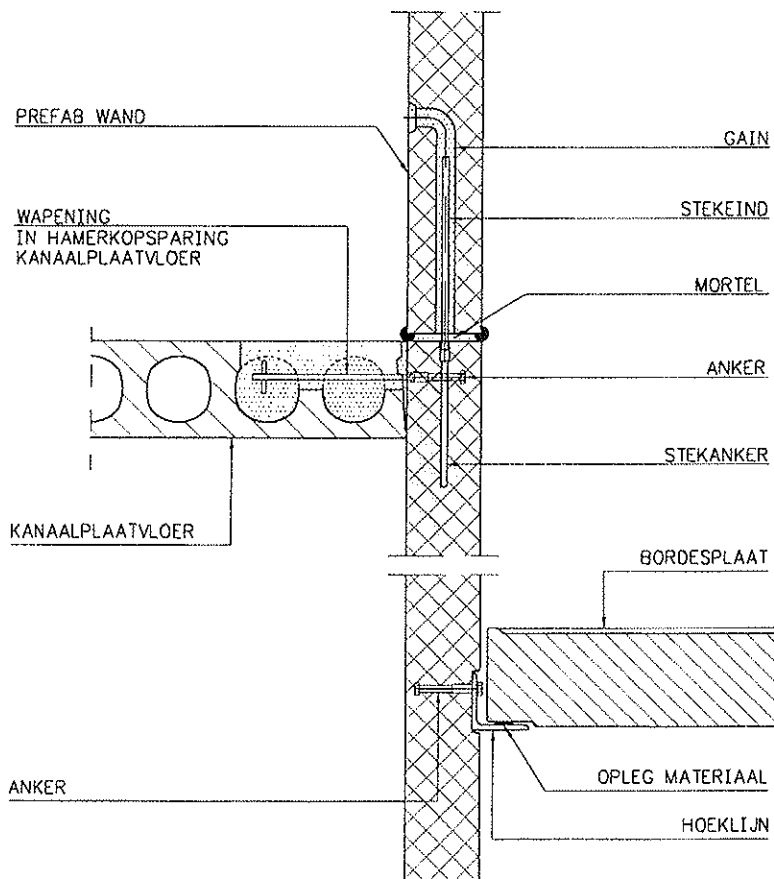

D 21

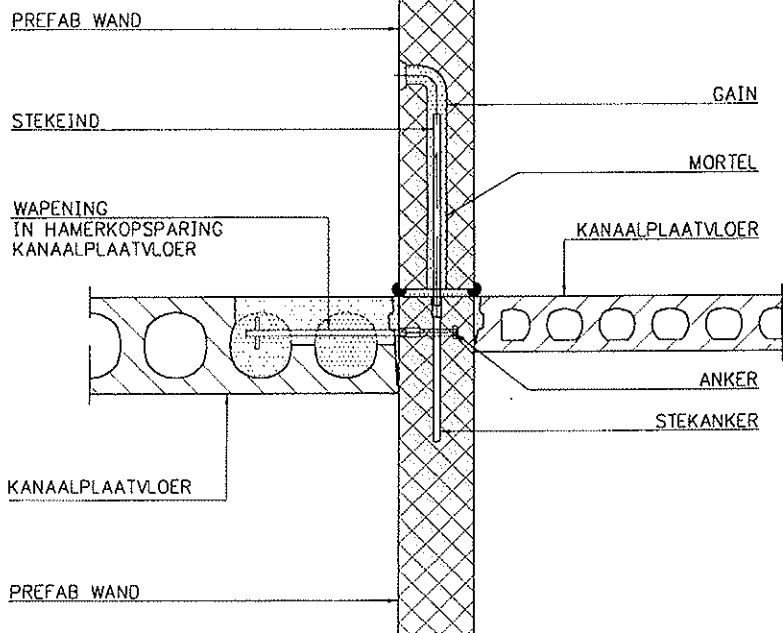

D 22  
D 23

D 22

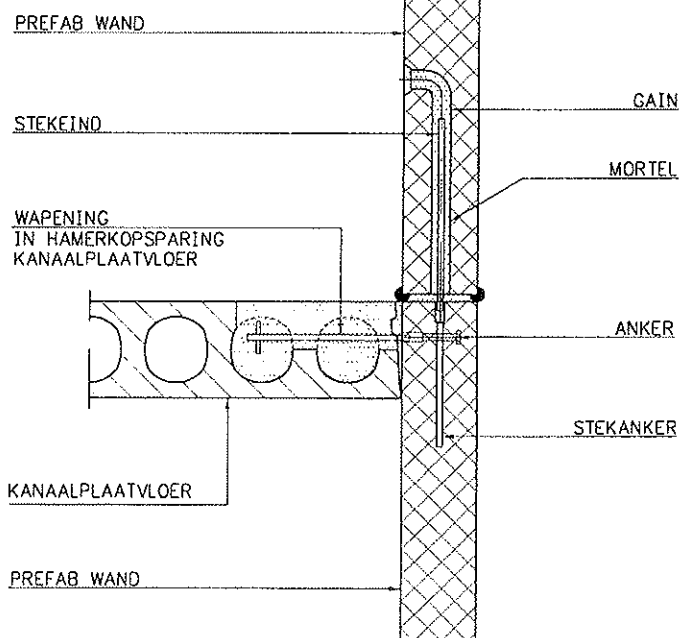

D 23



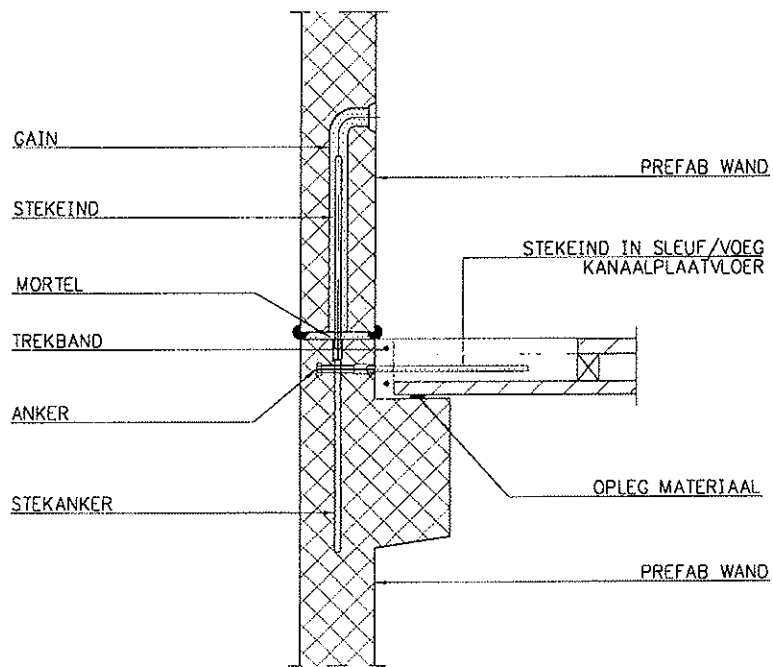

D 24

D 24

75

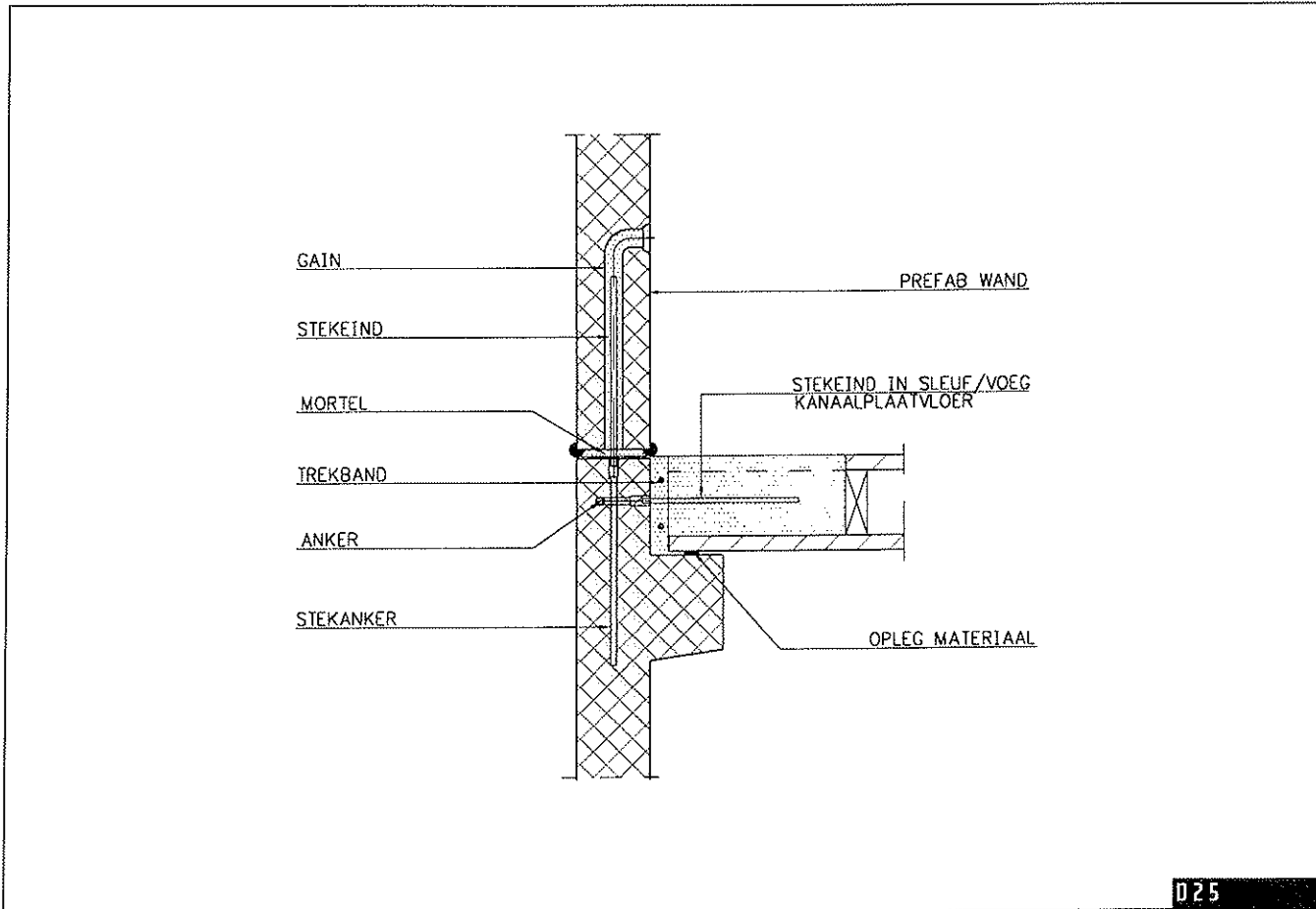

D25  
D26

D25

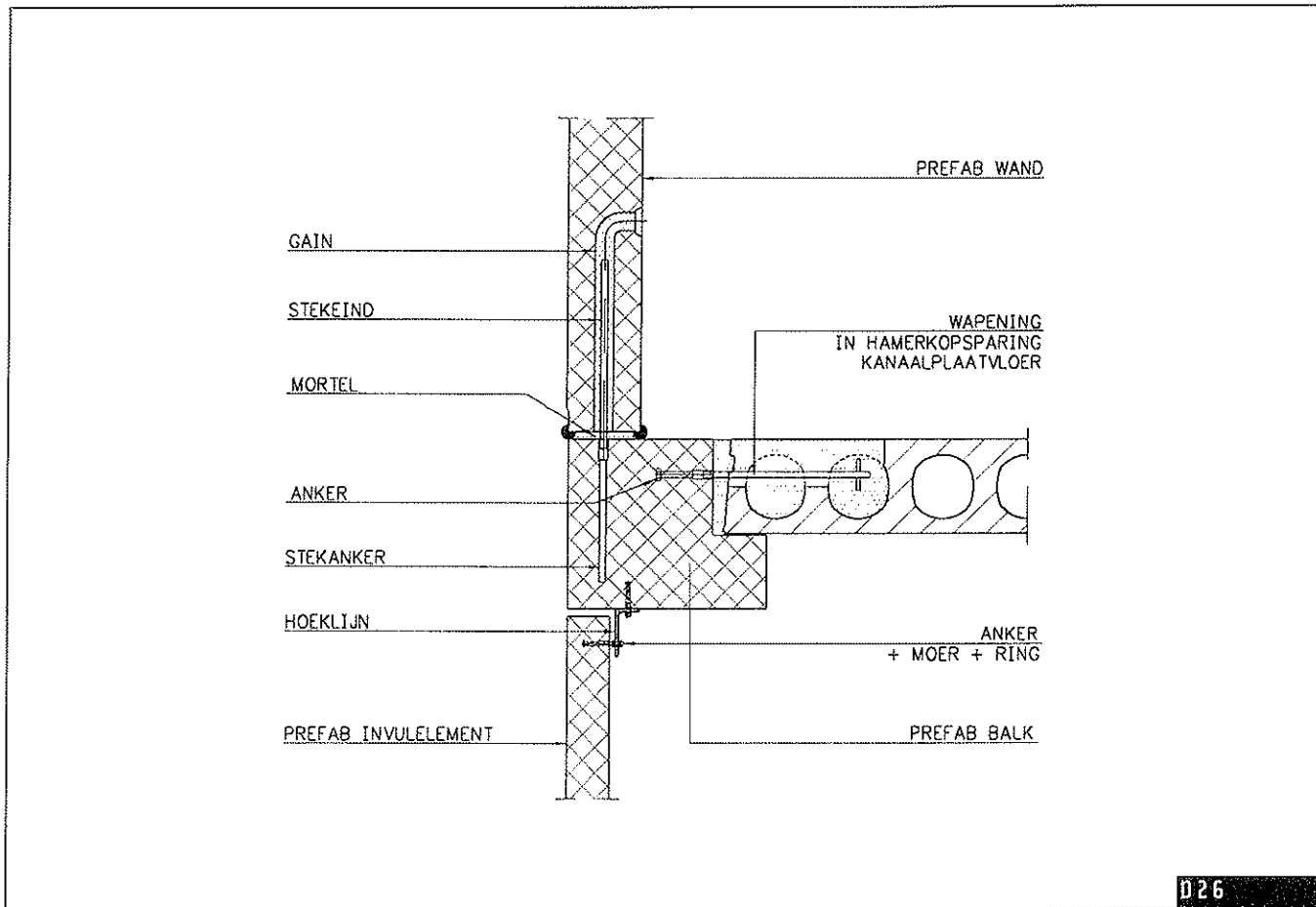

D26

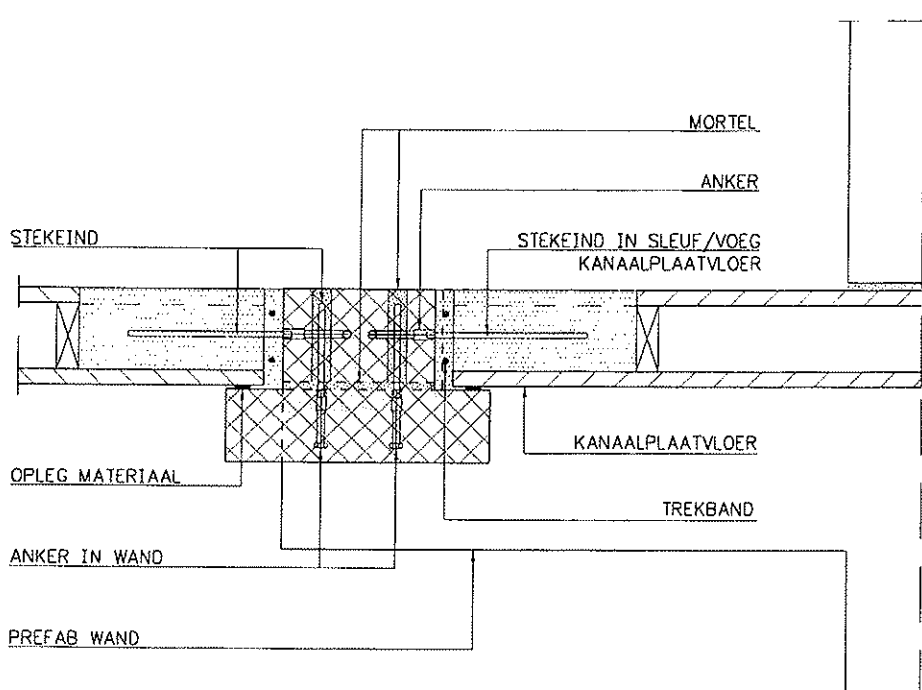

D 27

D 27

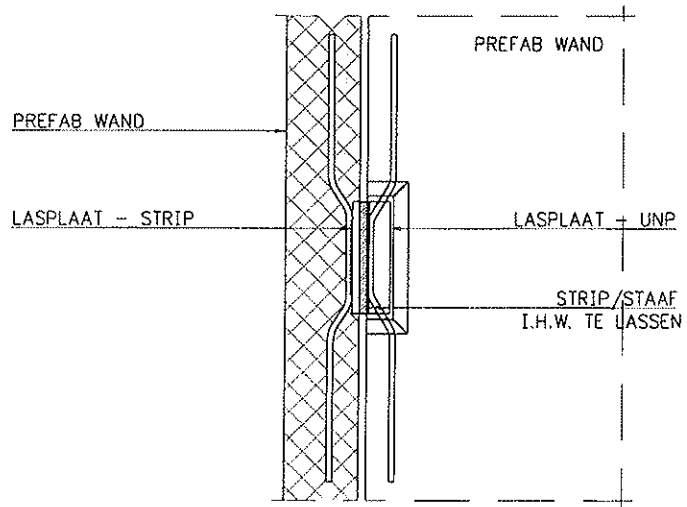
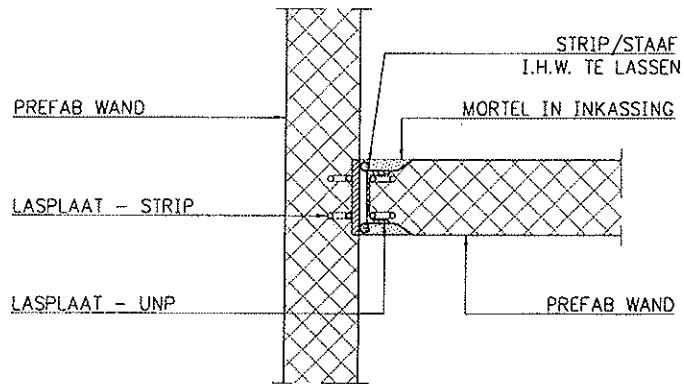

D 2 8

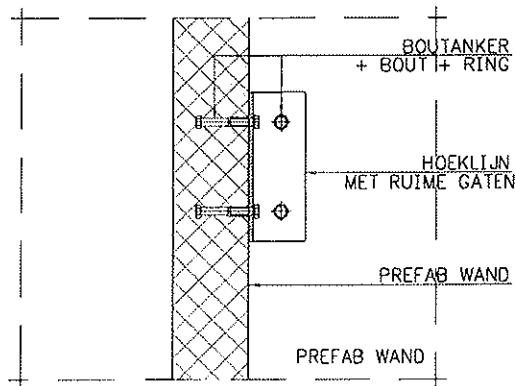
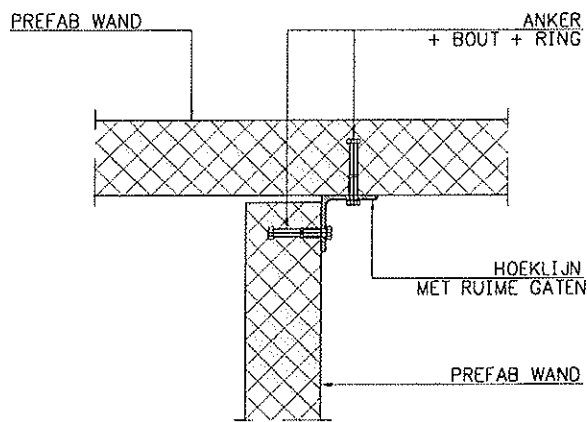

029

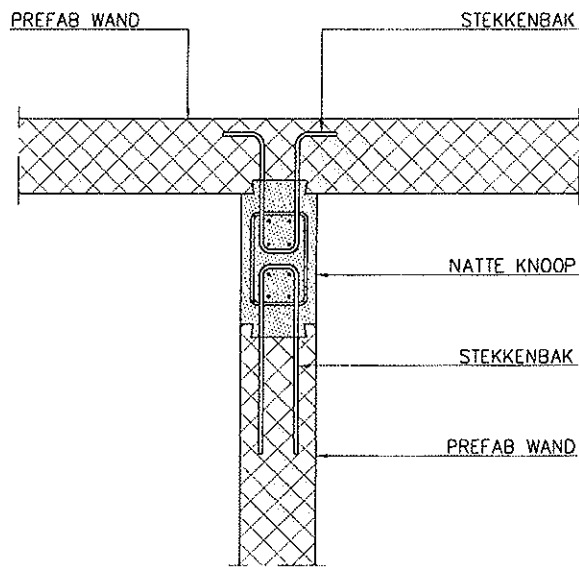

D30

D30

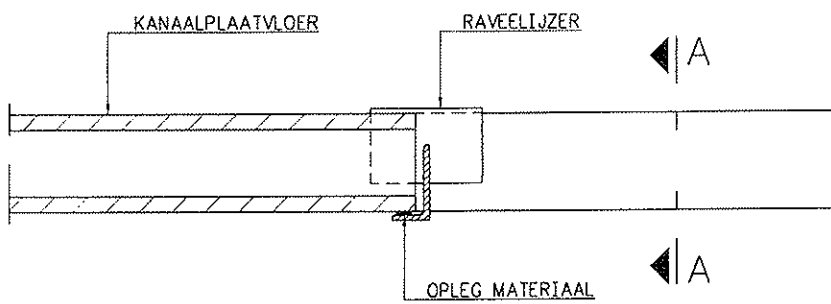

DRSN. A-A

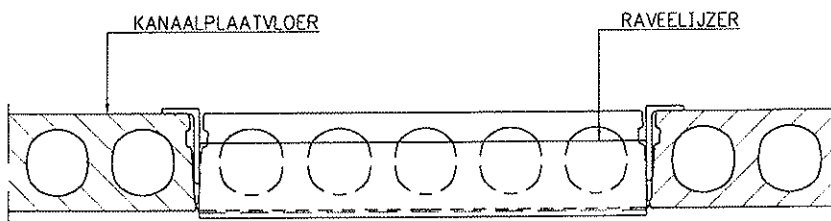

D31

D31

81

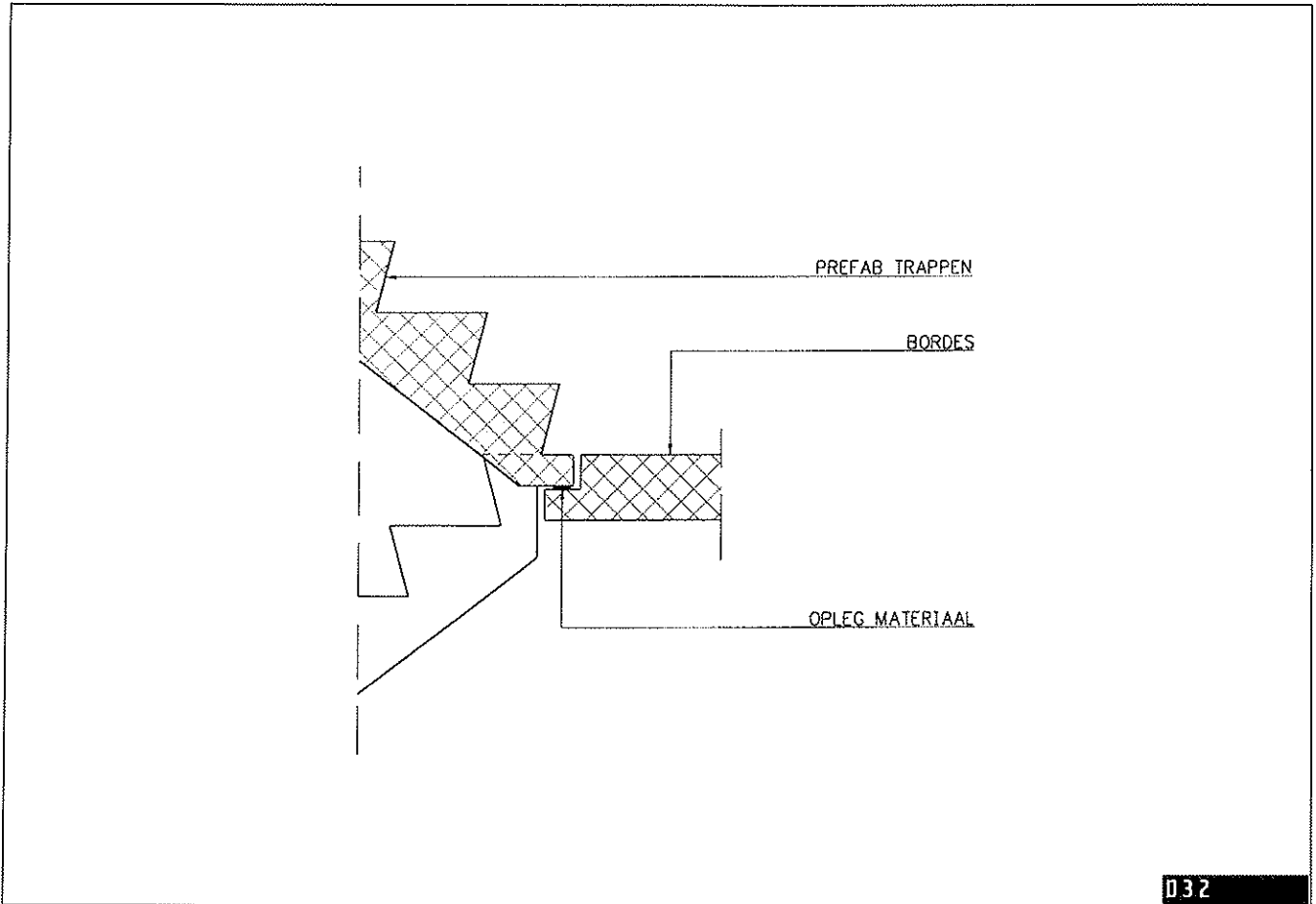

D32

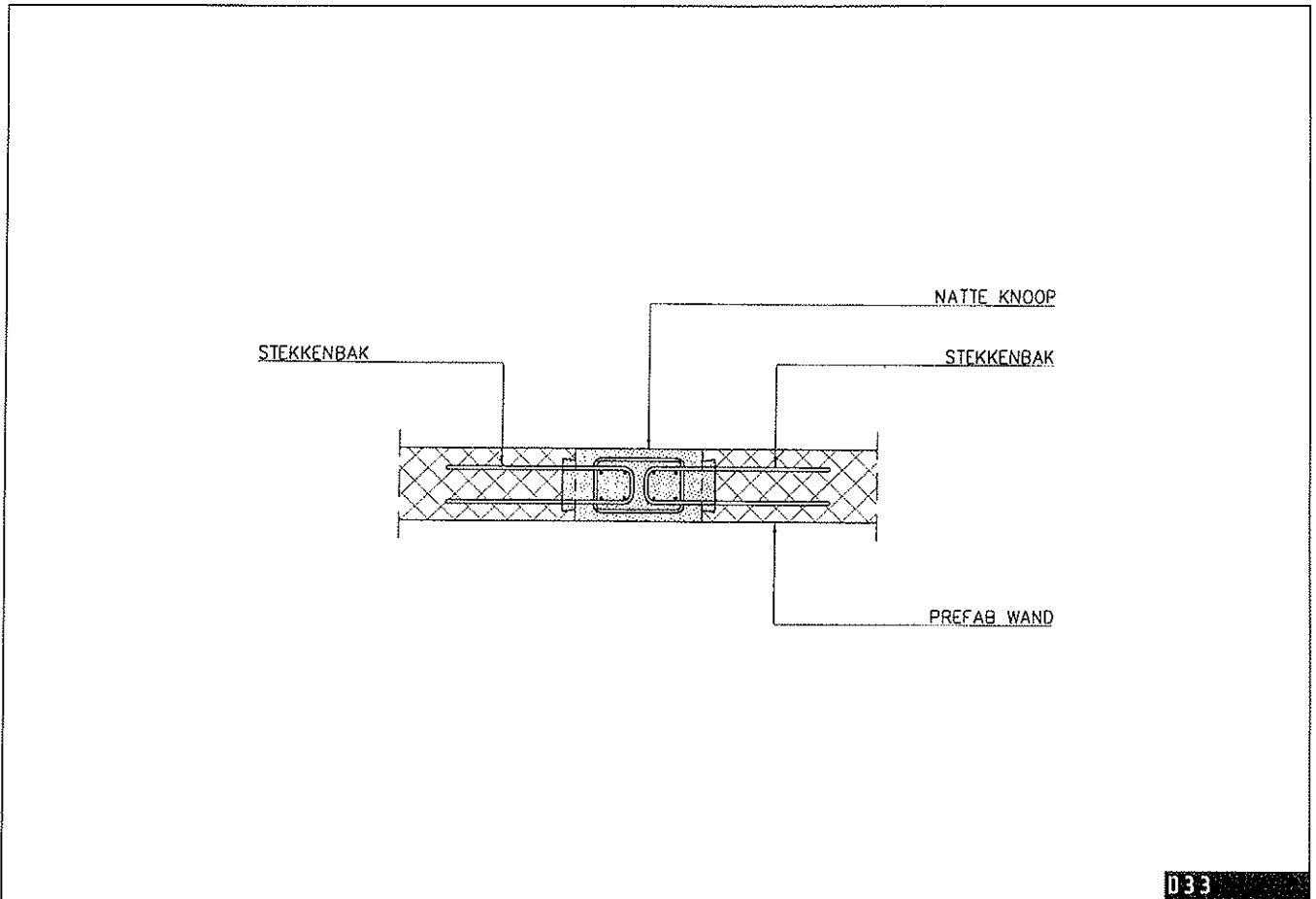

D32  
D33

D33



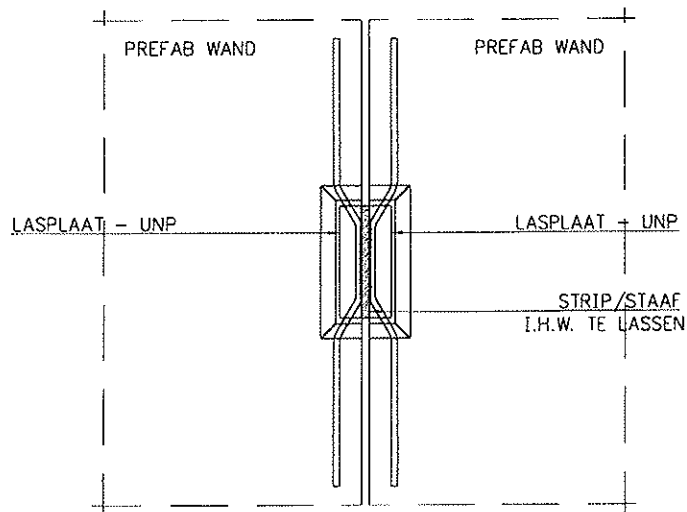
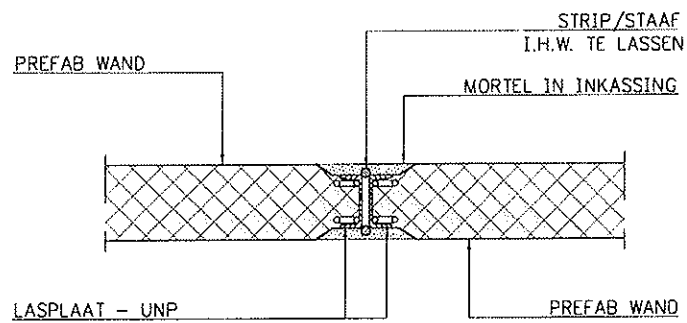

D34

D34

83

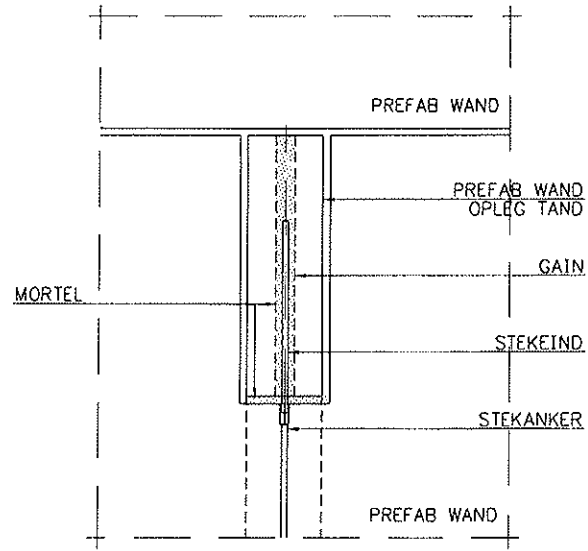
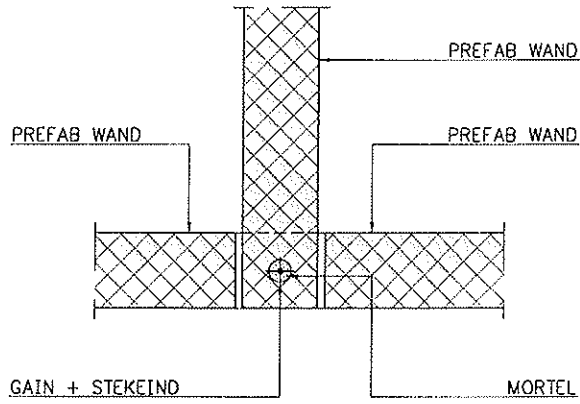

035

035

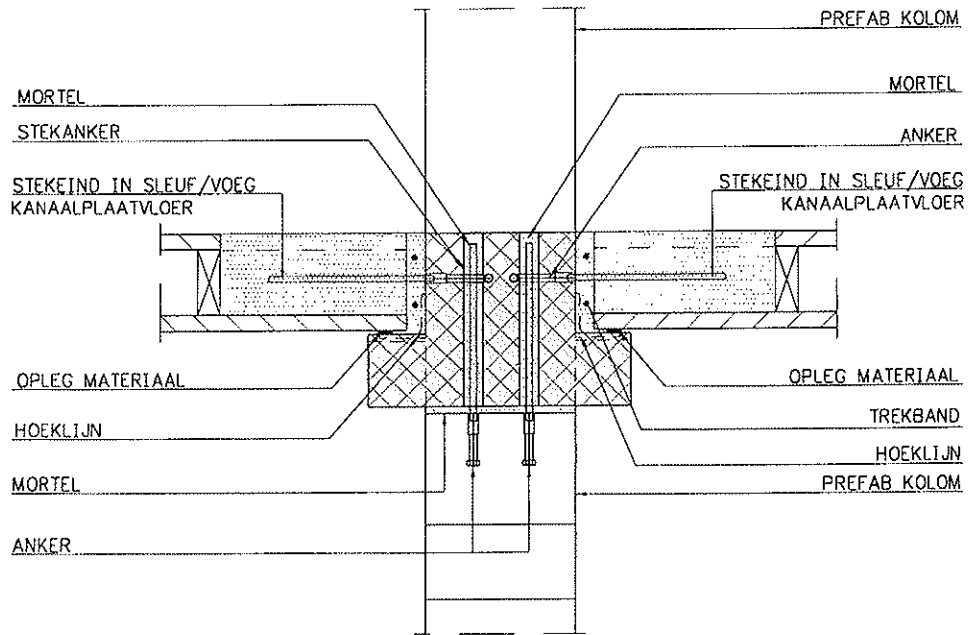

D36

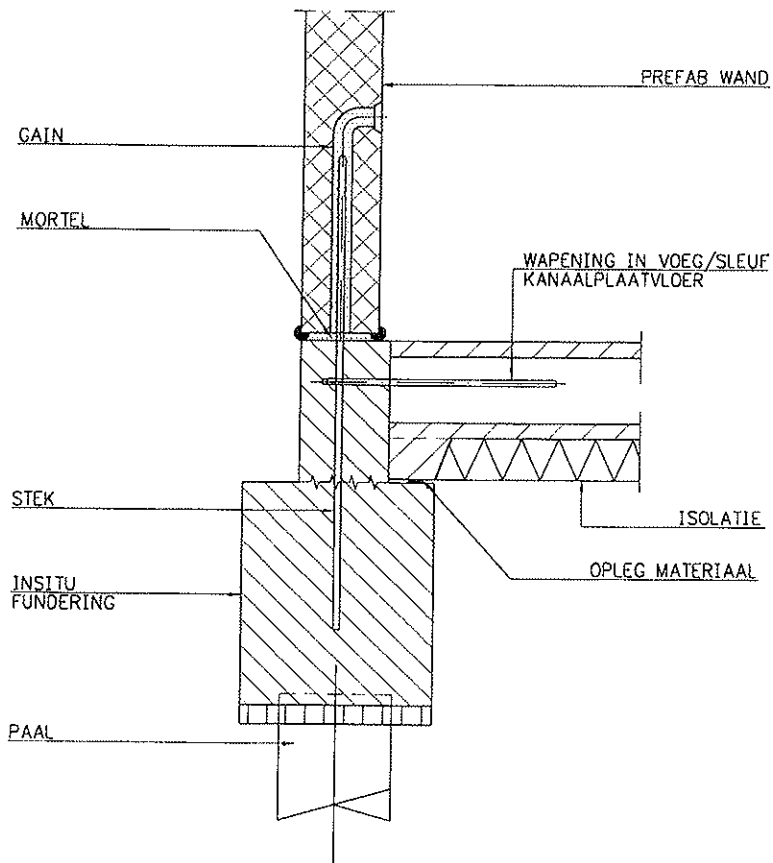

D36  
D37

D37

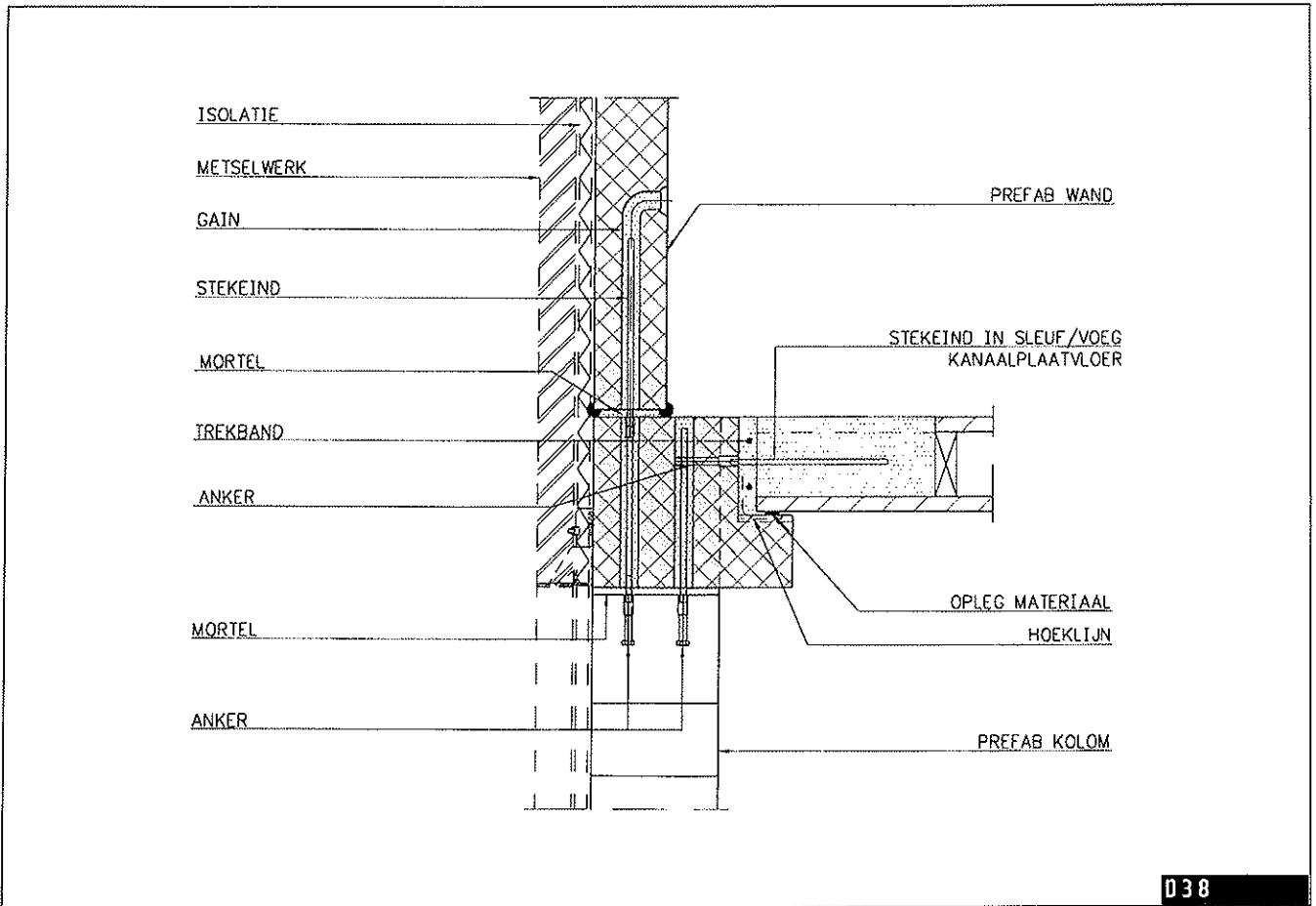

D38

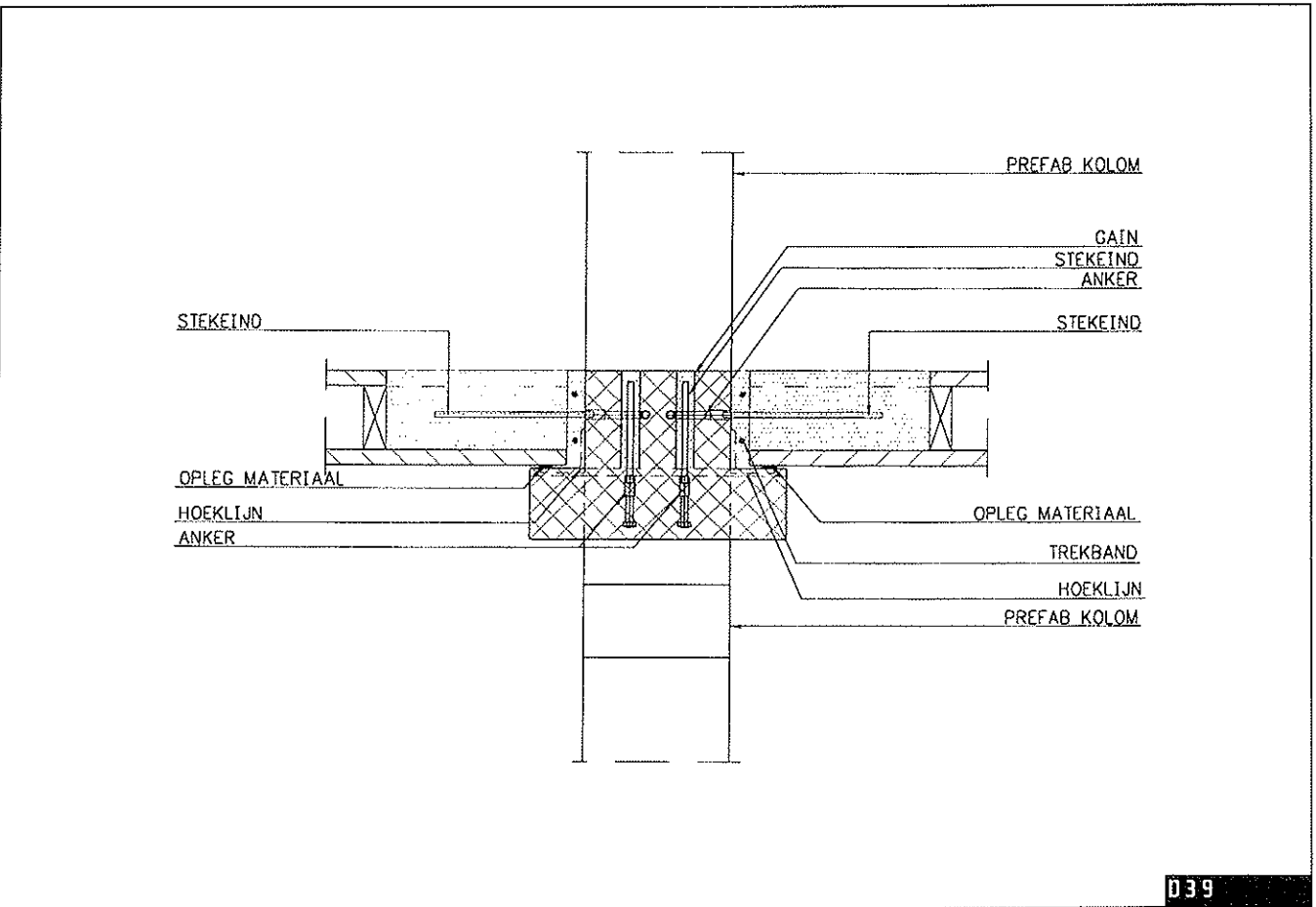

D39

D38  
D39

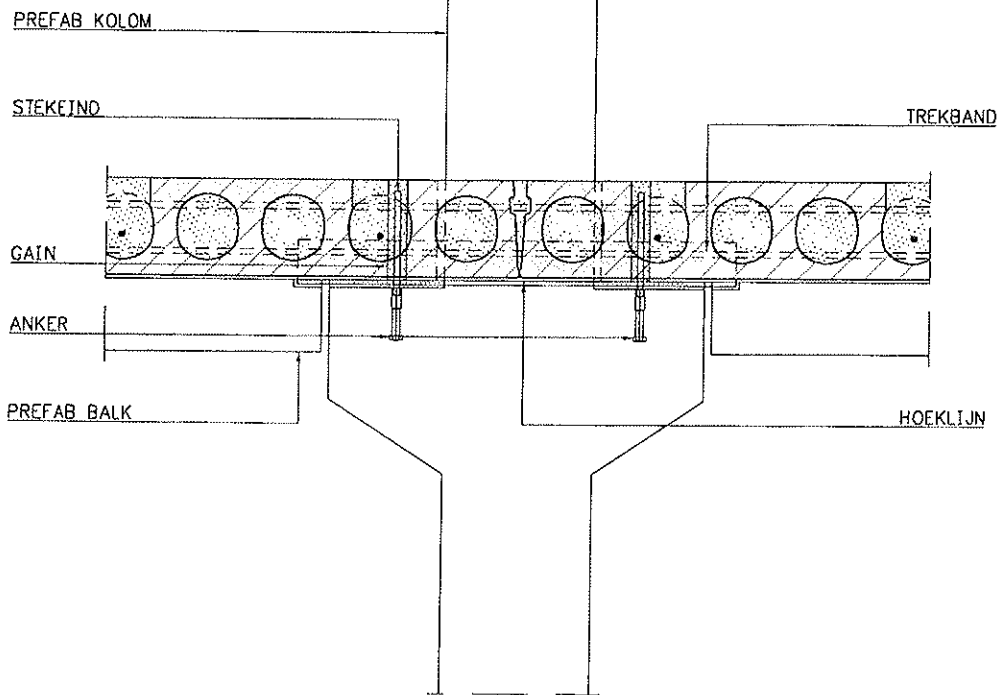

D40

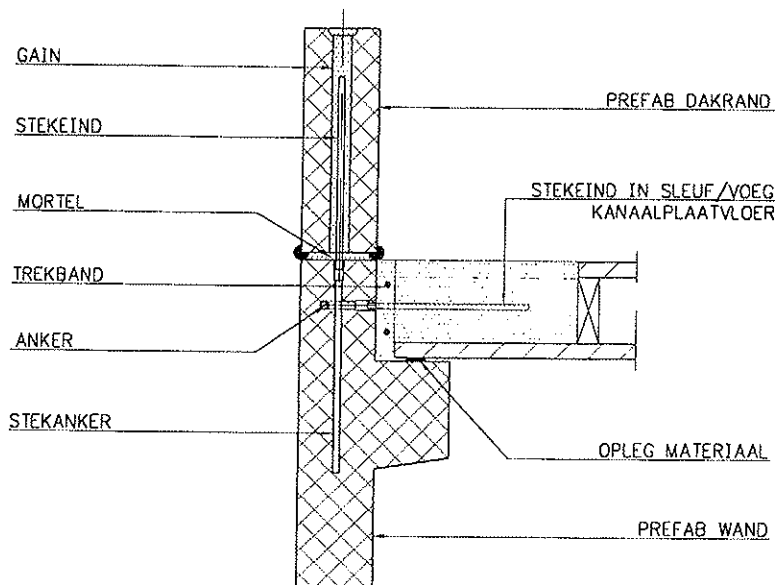

D40  
D41

D41

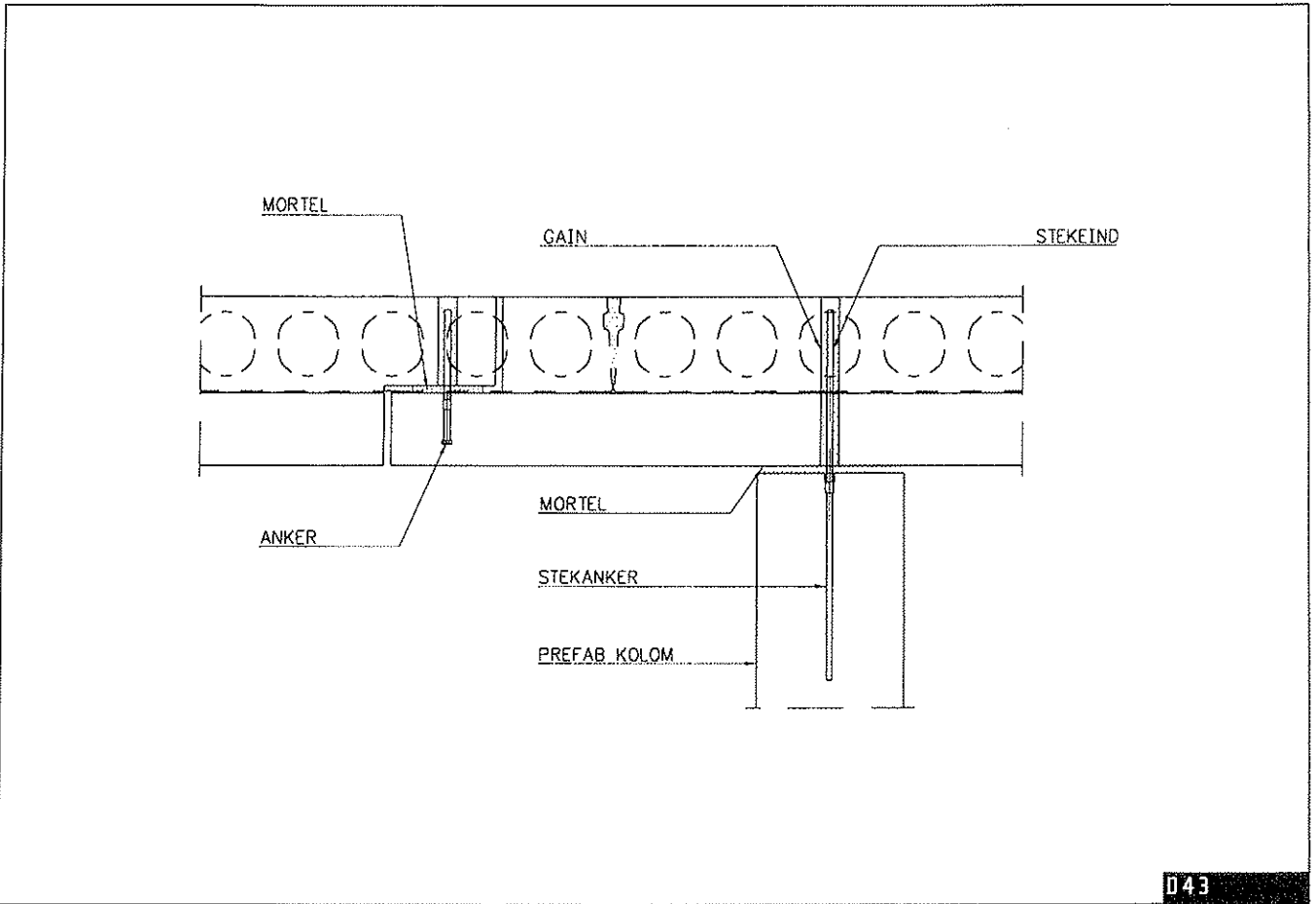
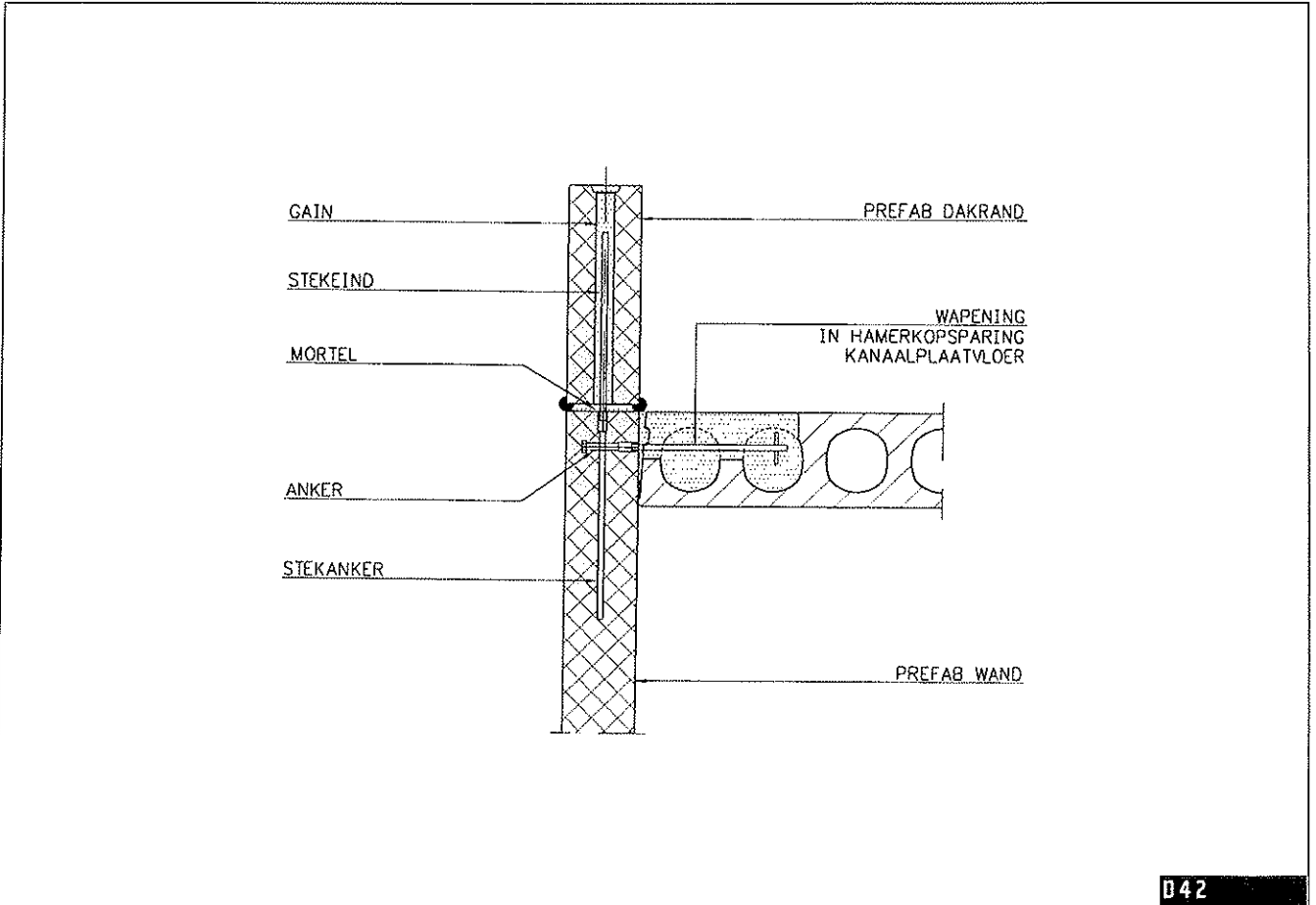

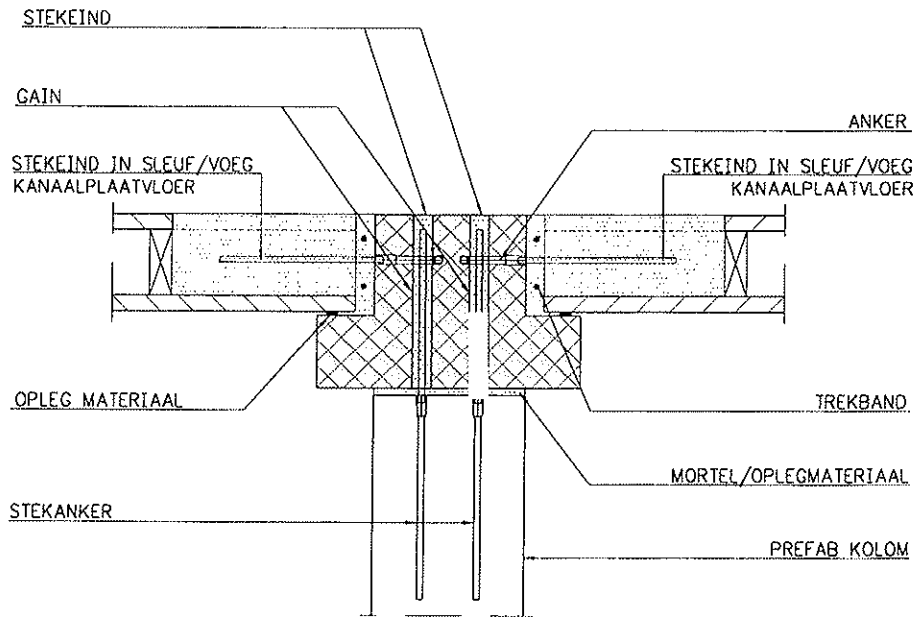

D 44

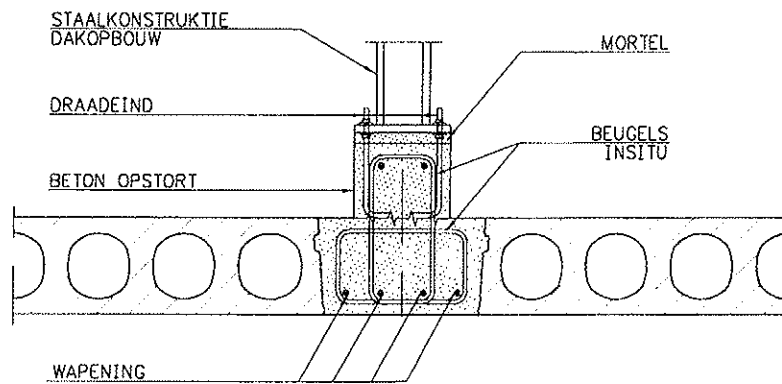

D 44  
D 45

D 45





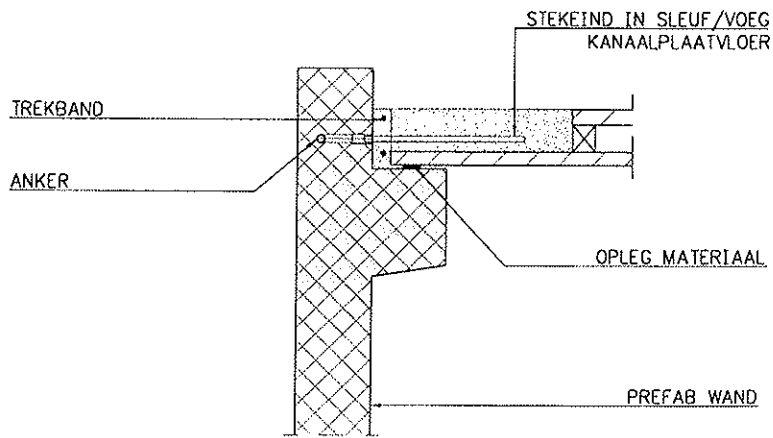

D 48

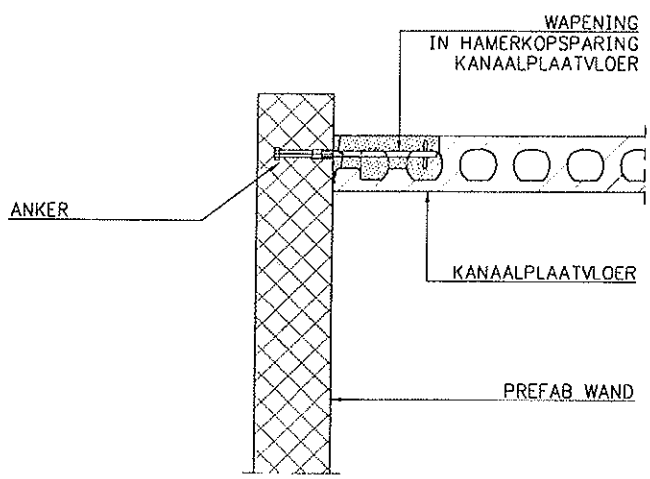

D 48  
D 49

D 49

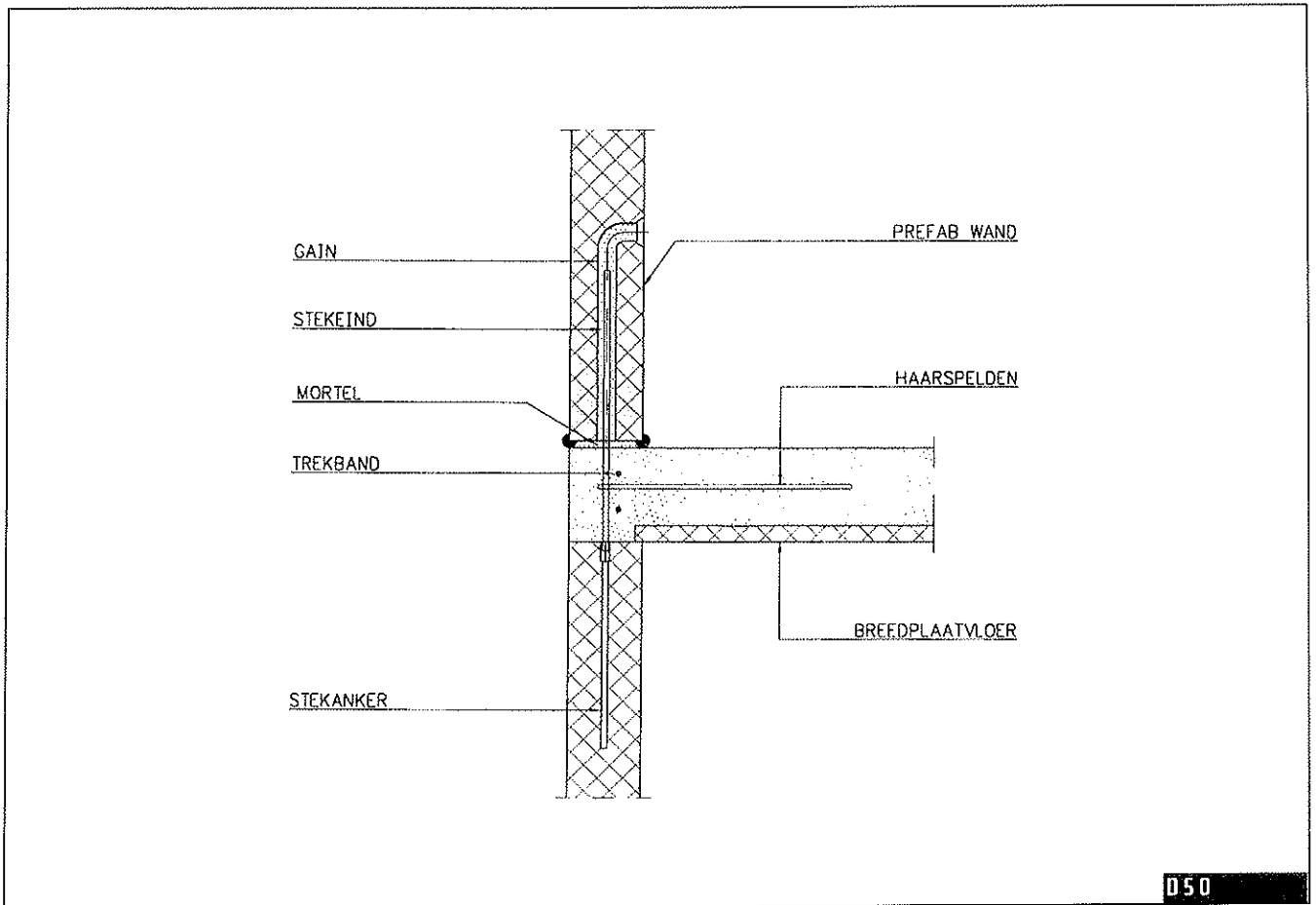

D50

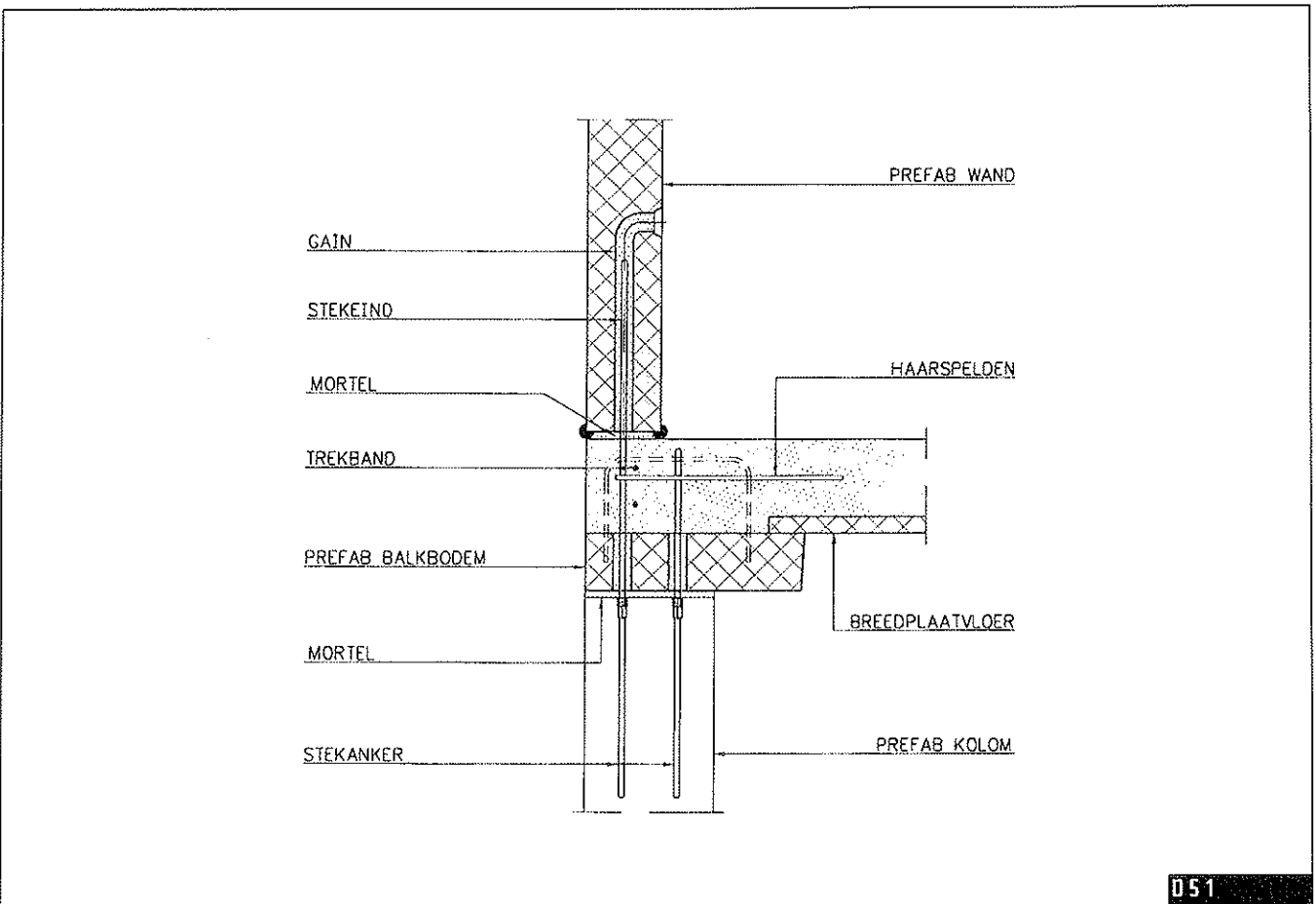

D51

D50  
D51

052  
053

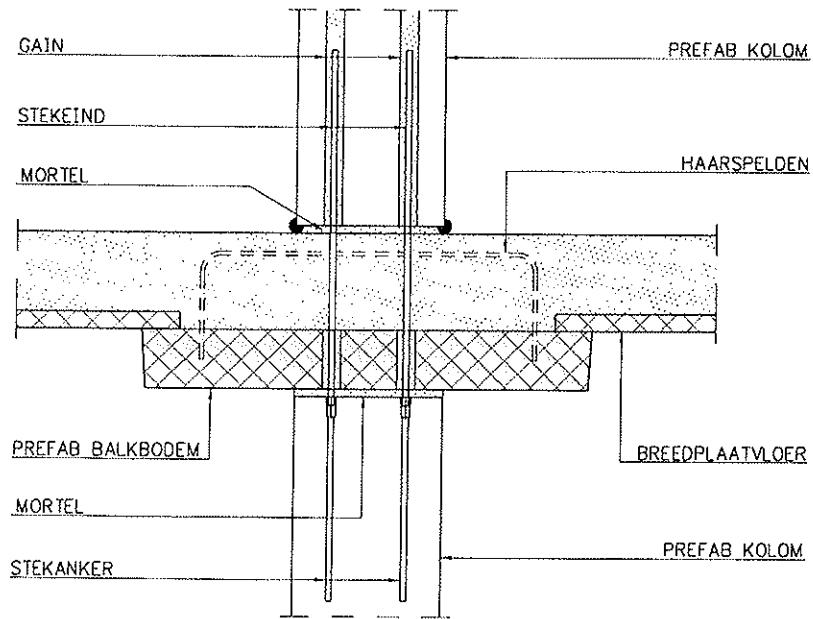

D52

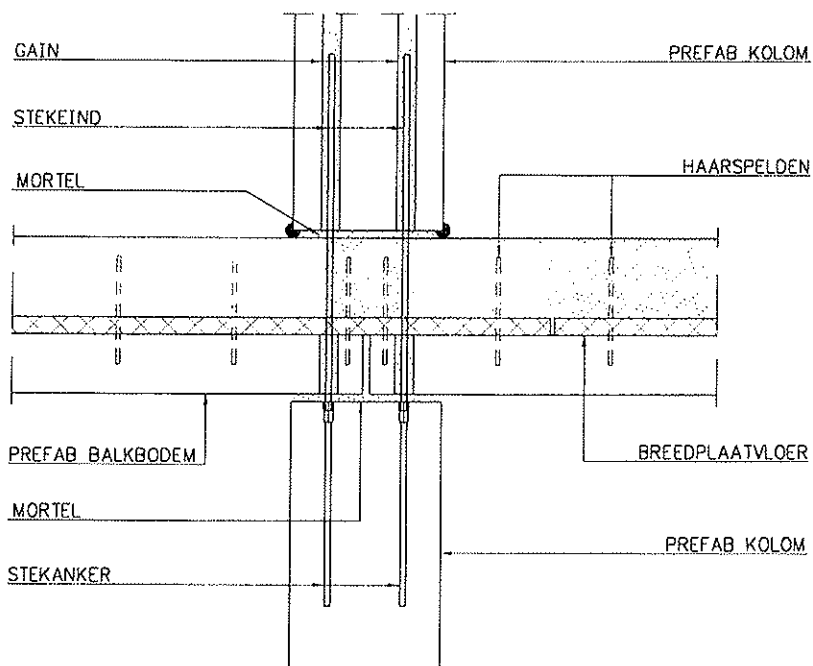

D53

D 54  
D 55

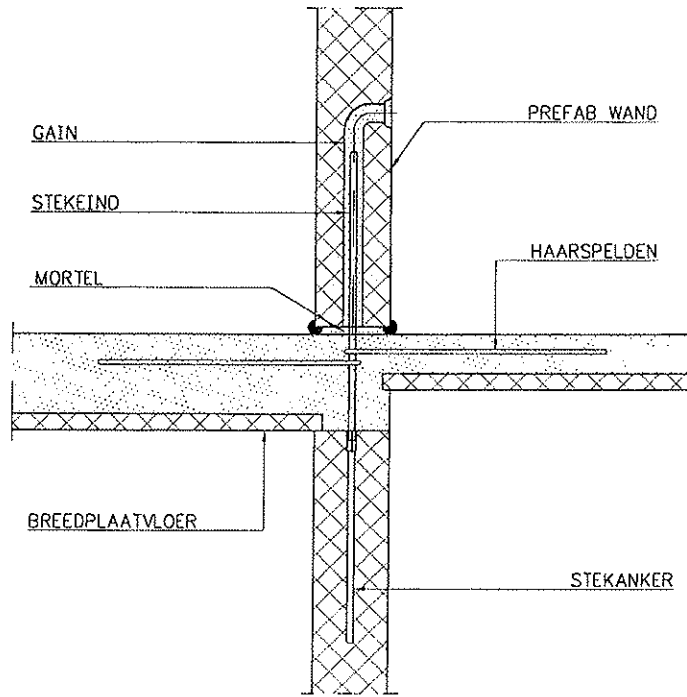

D 54

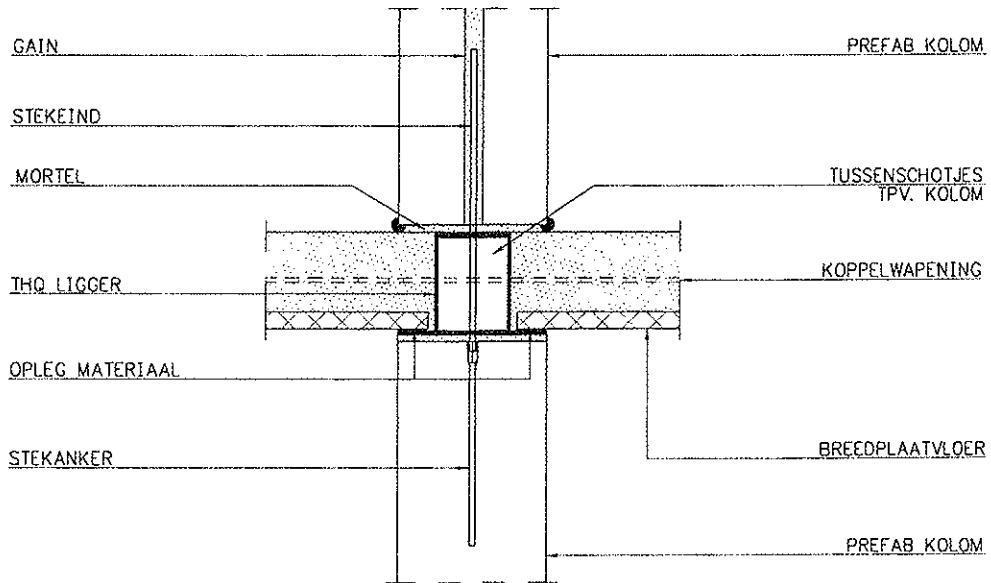

D 55

D 56  
D 57

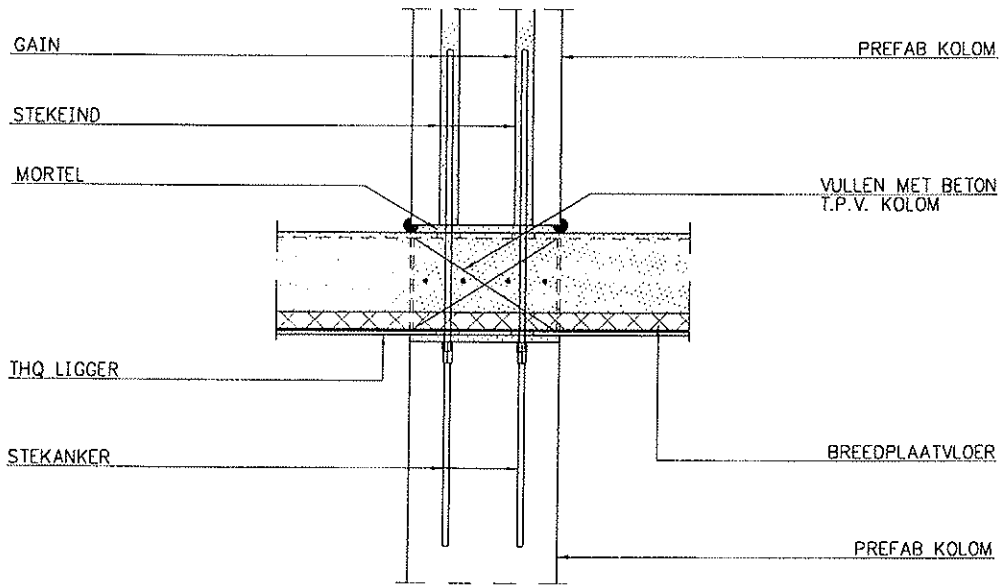

D 56

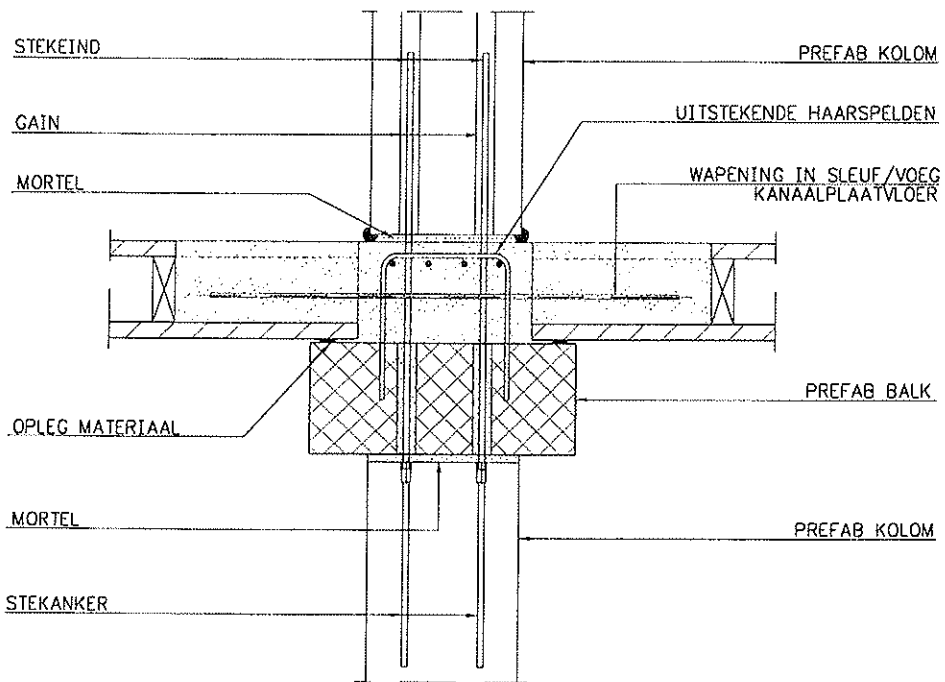

D 57

D 58  
D 59

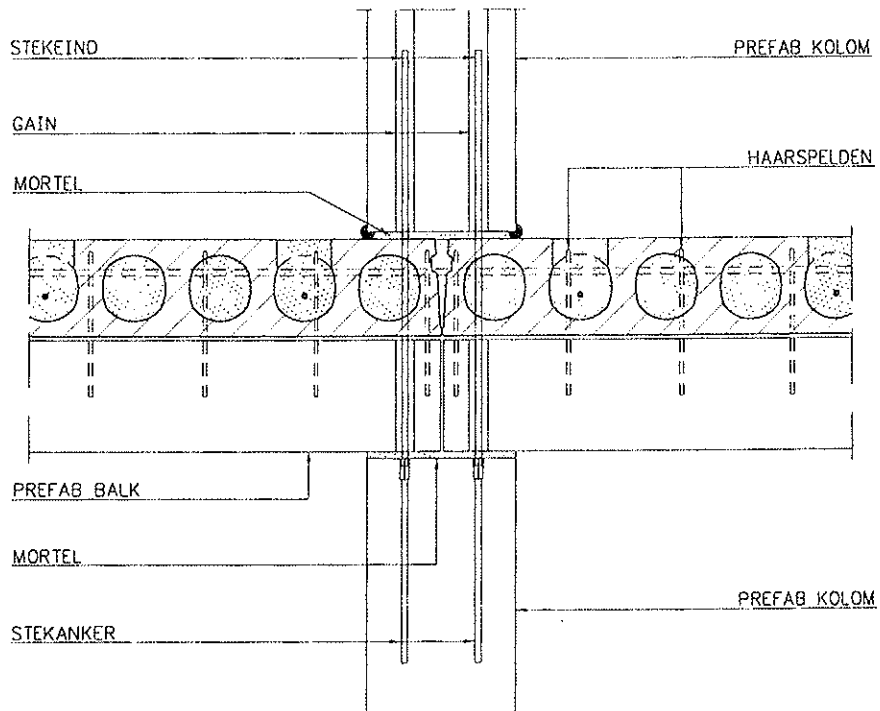

D 58

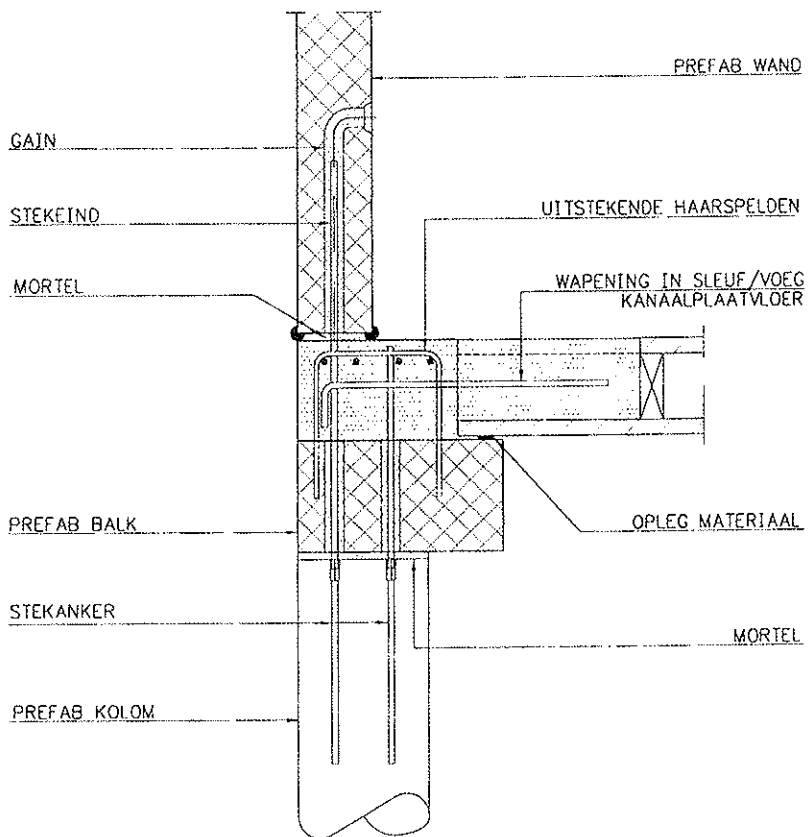

D 59

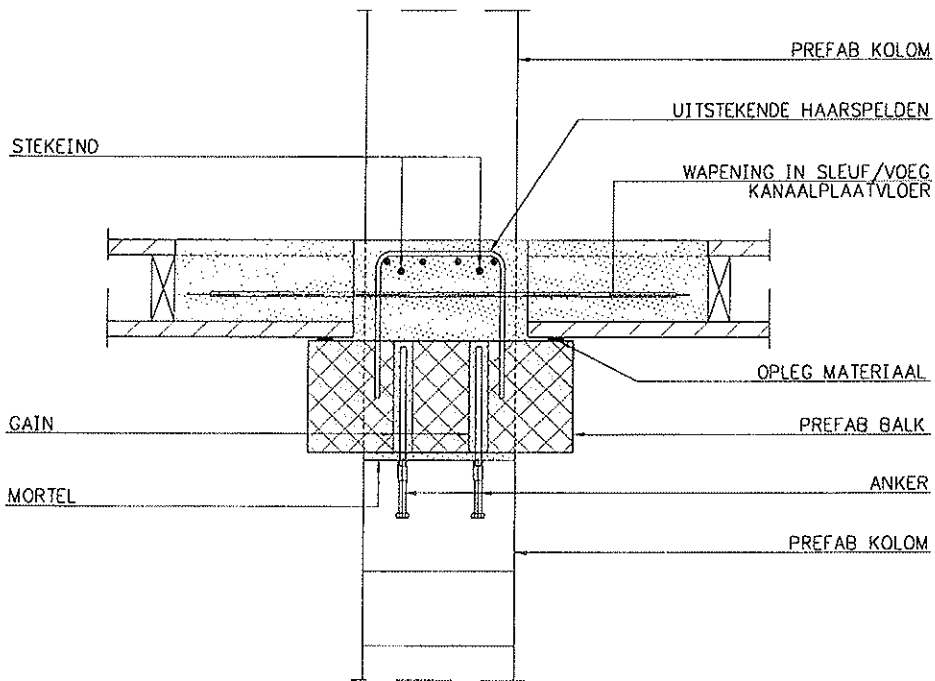

D 6 1

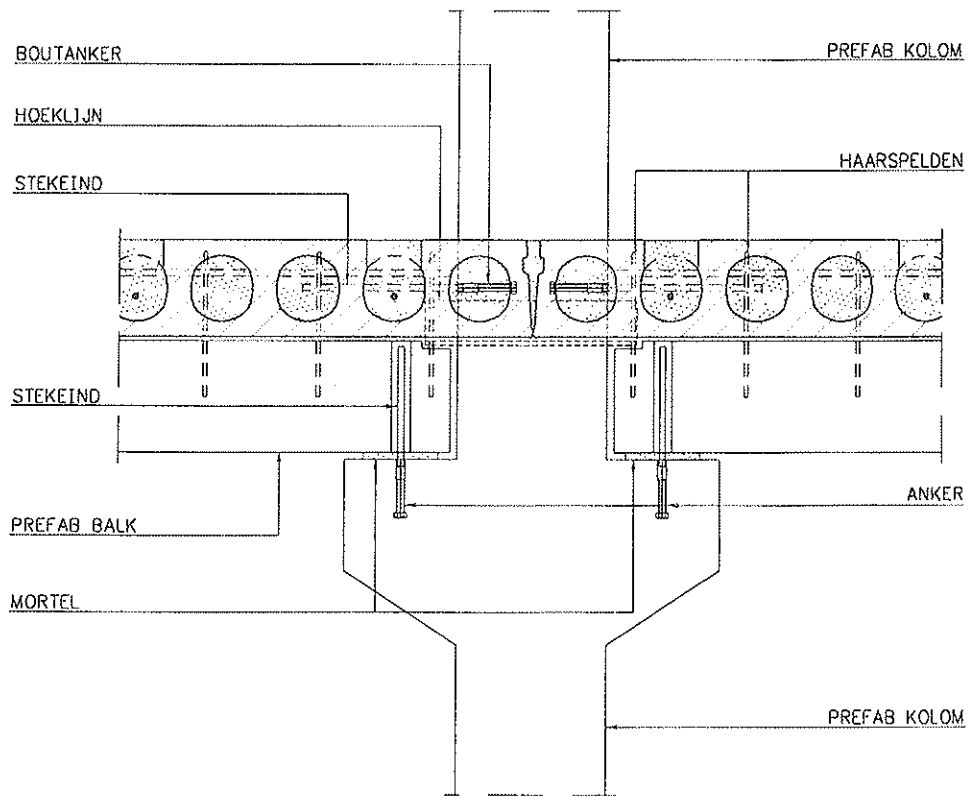



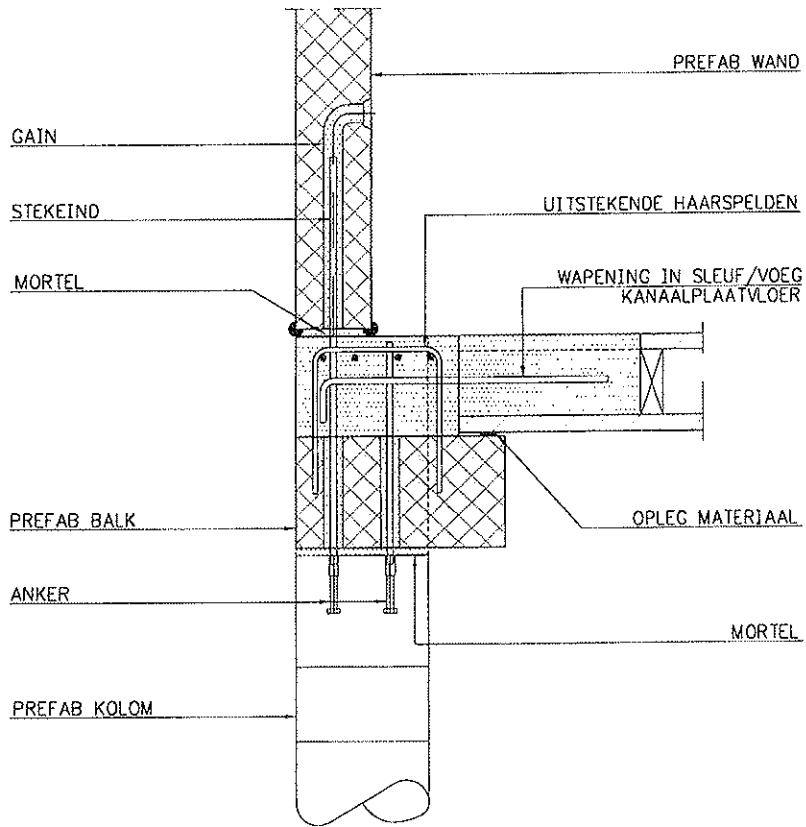

063

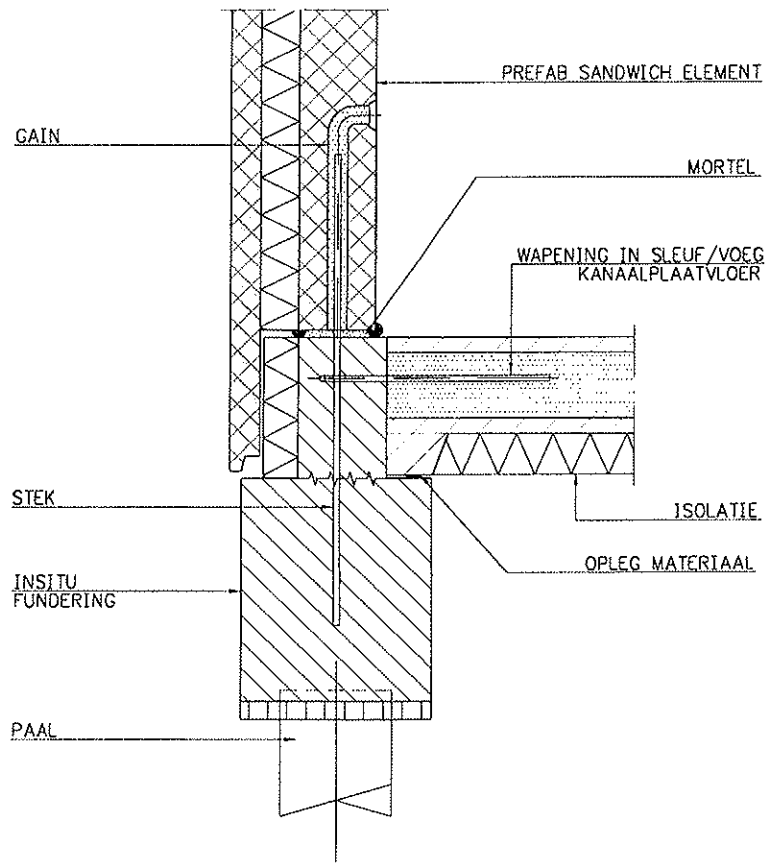

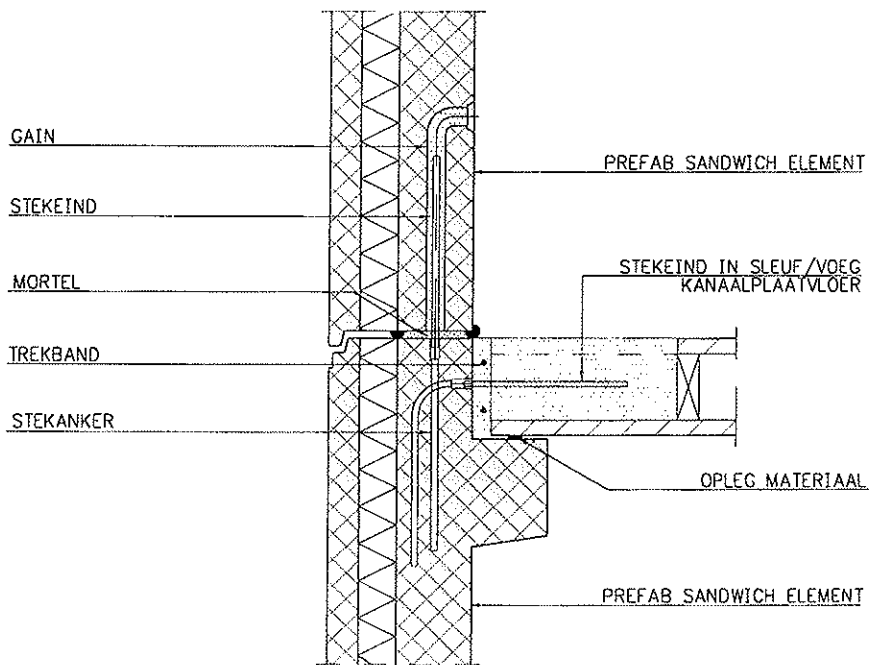

065

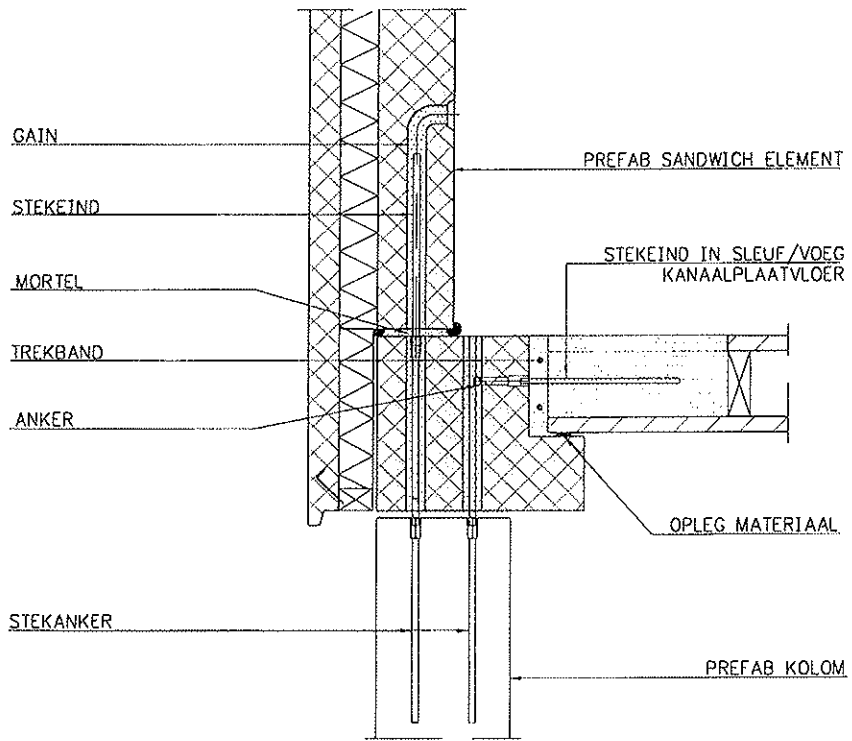

065

